

Scissors (Operating Scissors)

Blunt/Blunt

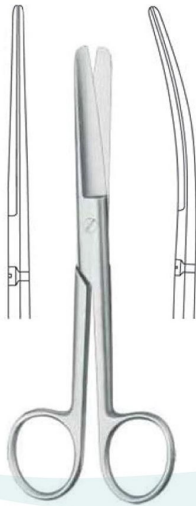

STANDARD

	Straight	Curved
12.0 cm/4¾"	100.11	105.11
13.0 cm/5"	100.13	105.13
14.5 cm/5¾"	100.14	105.14
15.5 cm/6¼"	100.15	105.15
16.5 cm/6½"	100.16	105.16
17.5 cm/7"	100.17	105.17
18.5 cm/7¼"	100.18	105.18
20.5 cm/8"	100.20	105.20

Blunt/Sharp

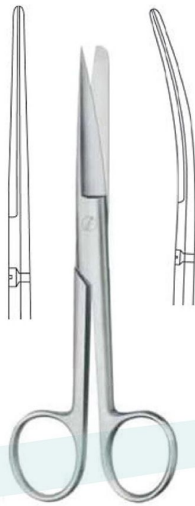

STANDARD

	Straight	Curved
12.0 cm/4¾"	102.11	107.11
13.0 cm/5"	102.13	107.13
14.5 cm/5¾"	102.14	107.14
15.5 cm/6¼"	102.15	107.15
16.5 cm/6½"	102.16	107.16
17.5 cm/7"	102.17	107.17
18.5 cm/7¼"	102.18	107.18
20.5 cm/8"	102.20	107.20

Sharp/Sharp

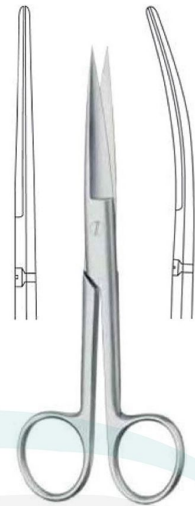

STANDARD

	Straight	Curved
12.0 cm/4¾"	104.11	109.11
13.0 cm/5"	104.13	109.13
14.5 cm/5¾"	104.14	109.14
15.5 cm/6¼"	104.15	109.15
16.5 cm/6½"	104.16	109.16

TC Edge

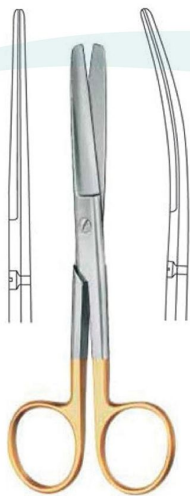

STANDARD

	Straight	Curved
14.5 cm/5¾"	902.14	903.14

SuperCut



STANDARD

	Straight	Curved
14.5 cm/5¾"	650.14	651.14

TC Edge

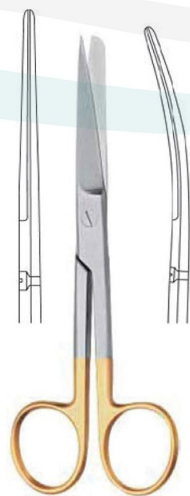

STANDARD

	Straight	Curved
14.5 cm/5¾"	904.14	905.14

TC Edge

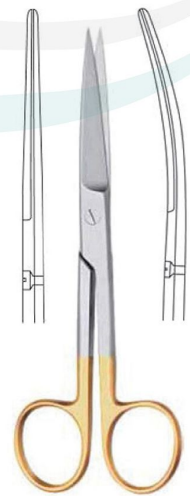

STANDARD

	Straight	Curved
14.5 cm/5¾"	906.14	907.14

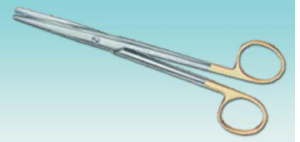

Scissors (Dissecting Scissors)

Delicate scissors

Incision scissors



13.0 cm/5"	Blunt/Blunt	120.13
14.5 cm/5¾"	Blunt/Blunt	120.14
13.0 cm/5"	Sharp/Blunt	122.13
14.5 cm/5¾"	Sharp/Blunt	122.14
13.0 cm/5"	Sharp/Sharp	124.13
14.5 cm/5¾"	Sharp/Sharp	124.14

13.0 cm/5"	Blunt/Blunt	125.13
14.5 cm/5¾"	Blunt/Blunt	125.14
13.0 cm/5"	Sharp/Blunt	127.13
14.5 cm/5¾"	Sharp/Blunt	127.14
13.0 cm/5"	Sharp/Sharp	129.13
14.5 cm/5¾"	Sharp/Sharp	129.14

136.14
14.5 cm/5¾"

DEAVER
142.15
14.5 cm/5¾"



TC Edge

SuperCut



DEAVER
14 cm/5½"

Straight	Curved
140.14	141.14

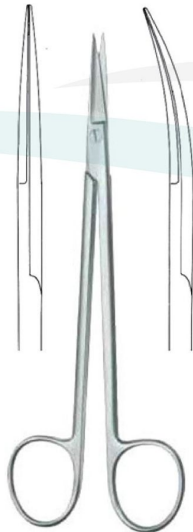

KELLY
16 cm/6¼"

Straight	Curved
226.16	227.16

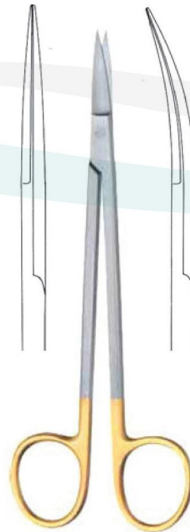

KELLY
16 cm/6¼"

Straight	Curved
992.16	993.16

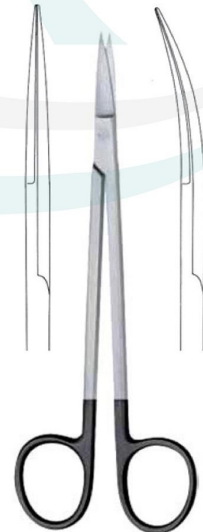

KELLY
16 cm/6¼"

Straight	Curved
656.16	657.16

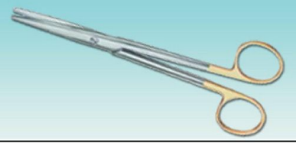

Scissors (Dissecting Scissor)



MAYO

	Straight	Curved
14.5 cm/5¾"	170.14	171.14
15.5 cm/6¼"	170.15	171.15
17.0 cm/6¾"	170.17	171.17
23.5 cm/9¼"	170.23	171.23

TC Edge



MAYO

	Straight	Curved
14.5 cm/5¾"	910.14	911.14
17.0 cm/6¾"	910.17	911.17
23.5 cm/9¼"	910.23	911.23

SuperCut



MAYO

	Straight	Curved
14.5 cm/5¾"	652.14	653.14
17.0 cm/6¾"	652.17	653.17
23.5 cm/9¼"	652.23	653.23



MAYO STILLE

	Straight	Curved
15.0 cm/6"	180.15	181.15
17.0 cm/6¾"	180.17	181.17

TC Edge



MAYO STILLE

	Straight	Curved
15.0 cm/6"	930.15	931.15
17.0 cm/6¾"	930.17	931.17

SuperCut



MAYO STILLE

	Straight	Curved
15.0 cm/6"	654.15	655.15
17.0 cm/6¾"	654.17	655.17

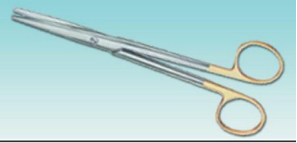

Scissors (Dissecting Scissors)

One toothed cutting edge



MAYO

14.5 cm/5¾"	915.14
17.0 cm/6¾"	915.17
23 cm/9"	915.23



MAYO-NOBLE

	Straight	Curved
17.0 cm/6¾"	190.17	191.17



MAYO-LEXER

16 cm/6¼"	953.16
-----------	---------------

Dissecting scissors

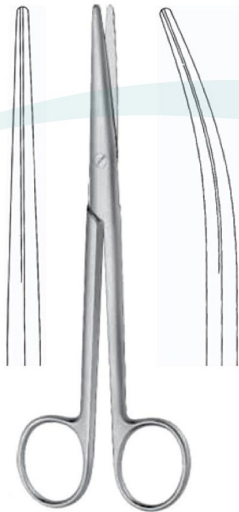

MAYO STILLE

	Straight	Curved
16 cm/6¼"	184.16	185.16
19.5 cm/7¾"	184.19	185.19
21.5 cm/8½"	184.21	185.21

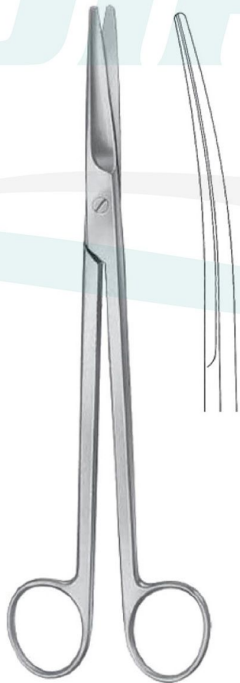

MAYO-HARRINGTON

	Straight	Curved
23 cm/9"	174.22	175.22
28 cm/11"		175.30

One toothed cutting edge



METZENBAUM

	Straight	Curved
14.5 cm/5¾"	298.14	299.14

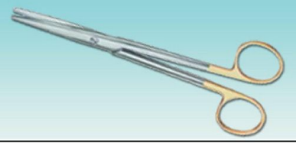

Scissors (Dissecting Scissors)



METZENBAUM

	Straight	Curved
14.5 cm/5¾"		
Sharp/Blunt	252.14	257.14
Blunt/Blunt	250.14	255.14
Sharp/Sharp	254.14	259.14
16 cm/6¼"		
Blunt/Blunt	280.16	285.16

TC Edge



METZENBAUM

	Straight	Curved
14.5 cm/5¾"	938.14	939.14

SuperCut



METZENBAUM

	Straight	Curved
14.5 cm/5¾"	658.14	659.14



METZENBAUM

	Straight	Curved
11.5 cm/4½"	248.11	249.11

TC Edge

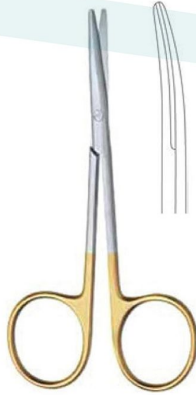

METZENBAUM

	Straight	Curved
11.5 cm/4½"	936.11	937.11

SuperCut



METZENBAUM

	Straight	Curved
11.5 cm/4½"	658.11	659.11



Scissors (Dissecting Scissors & Vascular Scissors)



METZENBAUM

	Straight	Curved
18.0 cm/7"	280.18	285.18
20.5 cm/8"	280.20	285.20
23 cm/9"	280.23	285.23
26.0 cm/10¼"	280.26	285.26
28.5 cm/11¼"	280.28	285.28
31.0 cm/30½"	280.31	285.31

TC Edge



METZENBAUM

	Straight	Curved
18.0 cm/7"	942.18	943.18
20.5 cm/8"	942.20	943.20
23 cm/9"	942.23	943.23
26.0 cm/10¼"	942.26	943.26
28.5 cm/11¼"	942.28	943.28
31.0 cm/30½"	942.31	943.31

SuperCut



METZENBAUM

	Straight	Curved
18.0 cm/7"	660.18	661.18
20.5 cm/8"	660.20	661.20
23 cm/9"	660.23	661.23
26.0 cm/10¼"	660.26	661.26
28.5 cm/11¼"	660.28	661.28
31.0 cm/30½"	660.31	661.31

Ligature scissors



One toothed cutting edge

SuperCut

TC Edge

METZENBAUM

11.5 cm/4½"	914.11
14.5 cm/5¾"	914.14
18.0 cm/7"	914.18
20.5 cm/8"	914.20
23 cm/9"	914.23
25.0 cm/9¾"	914.25
30.0 cm/11¾"	914.30

Vascular scissors



TC Edge

METZENBAUM-THOREK

20 cm/8"	945.20
23 cm/9"	945.23
28 cm/11"	945.28

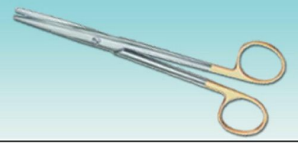

Scissors (Dissecting Scissors)

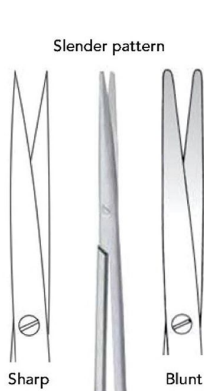

BABY METZENBAUM
14.5 cm/5¾"

	Straight	Curved
Blunt/Blunt	326.14	327.14
Sharp/Sharp	328.14	329.14

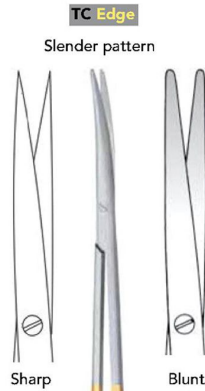

BABY METZENBAUM
14.5 cm/5¾"

	Straight	Curved
Blunt/Blunt	954.14	955.14
Sharp/Sharp	956.14	957.14



METZENBAUM-FINO
14.5 cm/5¾"

	665.14
--	---------------

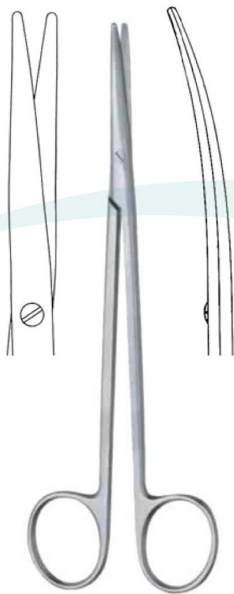

NELSON-METZENBAUM

	Straight	Curved
18.0 cm/7"	330.18	331.18
20.5 cm/8¼"	330.20	331.20
23.0 cm/9"	330.23	331.23
26.0 cm/10¼"	330.26	331.26
28.5 cm/11¼"	330.28	331.28

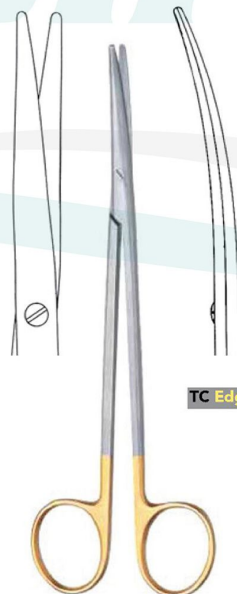

NELSON-METZENBAUM

	Straight	Curved
18.0 cm/7"	960.18	961.18
20.5 cm/8¼"	960.20	961.20
23.0 cm/9"	960.23	961.23
26.0 cm/10¼"	960.26	961.26
28.5 cm/11¼"	960.28	961.28

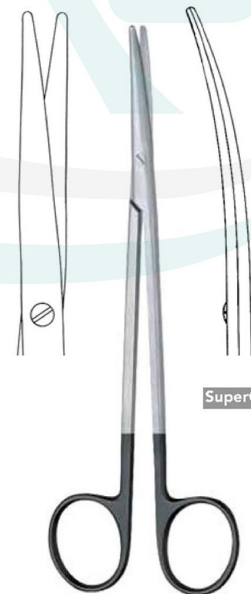

NELSON-METZENBAUM

	Straight	Curved
18.0 cm/7"	664.18	665.18
20.5 cm/8¼"	664.20	665.20
23.0 cm/9"	664.23	665.23
26.0 cm/10¼"	664.26	665.26
28.5 cm/11¼"	664.28	665.28

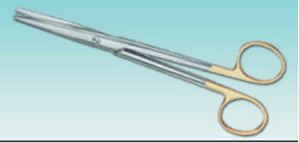

Scissors (Dissecting Scissors)

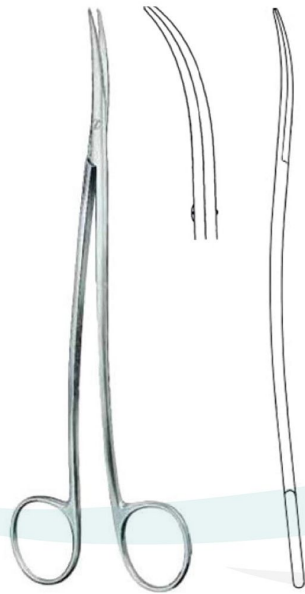

Slender pattern
S-shaped

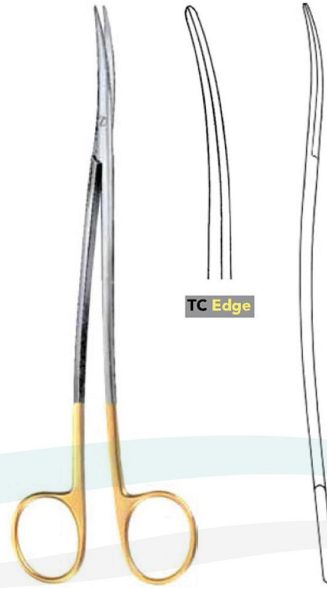

METZENBAUM-FINO
18.0 cm/7" **335.18**
20.5 cm/8" **335.20**
23 cm/9" **335.23**

METZENBAUM-FINO
18.0 cm/7" **967.18**
20.5 cm/8" **967.20**
23 cm/9" **967.23**

DIPRO

Sharp/Sharp

Blunt/Blunt

Delicate slender pattern

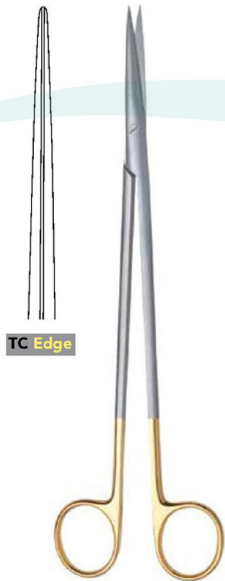

METZENBAUM-FINO
18.0 cm/7" **962.18**
20.0 cm/8" **962.20**
23.0 cm/9" **962.23**



METZENBAUM-FINO
20.0 cm/8" **965.20**
23.0 cm/9" **965.23**

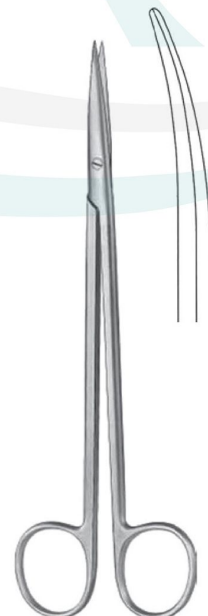

METZENBAUM-NELSON
18 cm/7" **284.18**
20.5 cm/8" **284.20**

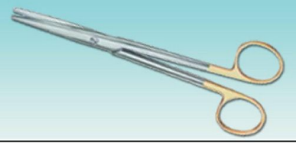

Scissors (Dissecting Scissors)

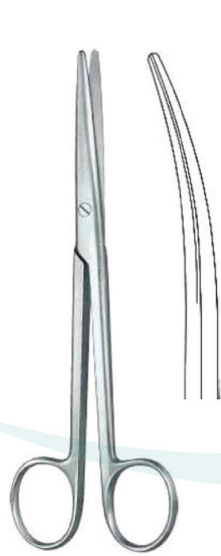

LEXER
16 cm/6¼"
Straight Curved
310.16 **311.16**



LEXER
Straight Curved
16 cm/6¼" **950.16** **951.16**
21 cm/8¼" **950.21** **951.21**



LEXER
16 cm/6¼"
Straight Curved
662.16 **663.16**

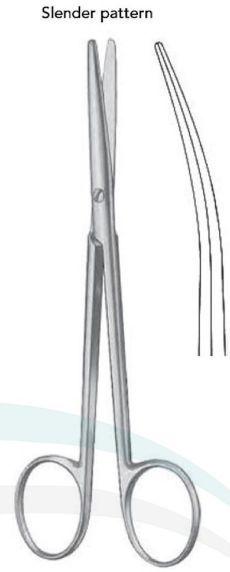

LEXER-FINO
16 cm/6¼"
Straight Curved
324.16 **325.16**



LEXER-BABY
10 cm/4"
Straight Curved
320.10 **321.10**

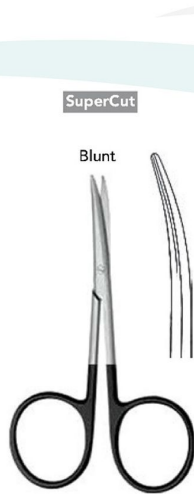

LEXER-BABY
10 cm/4"
Straight Curved
662.10 **663.10**

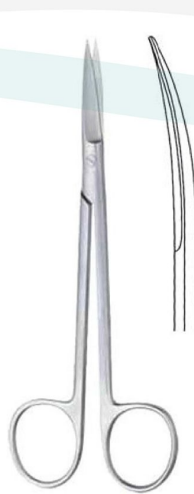

JOSEPH
14.5 cm/5¾"
Straight Curved
350.14 **351.14**



JOSEPH
14.5 cm/5¾"
Straight Curved
948.14 **949.14**



JOSEPH
14.5 cm/5¾"
Straight Curved
666.14 **667.14**

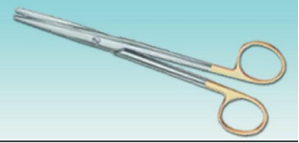

Scissors (Delicate Dissecting Scissors)

KILNER		KILNER		REYNOLDS		REYNOLDS		REYNOLDS	
12 cm/4¾"	359.12	12 cm/4¾"	669.12	15.5 cm/6¼"	364.15	15.5 cm/6¼"	365.15	15.5 cm/6¼"	671.15
15 cm/6"	359.15	15 cm/6"	669.15	15.5 cm/6¼"		18.0 cm/7¼"	365.18	18.0 cm/7¼"	671.18

TOENNIS-ADSON		TOENNIS-ADSON		TOENNIS				Dissecting scissors	
17.5 cm/7"	459.17	17.5 cm/7"	965.17	18 cm/7"		14.5 cm/5¾"		13 cm/5"	
				Straight	Curved	Straight	Curved		
				461.18	462.18	362.14	363.14		

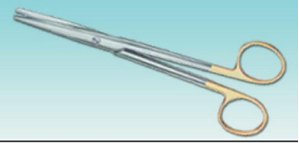

Scissors (Dissecting & Vascular Scissors)

Delicate pattern one cutting edge with knife cut
with knife cut

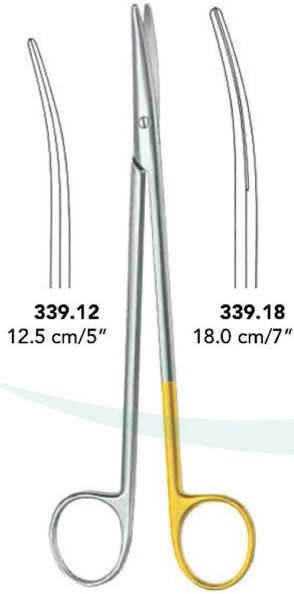

339.12
12.5 cm/5"

339.18
18.0 cm/7"

SALYER

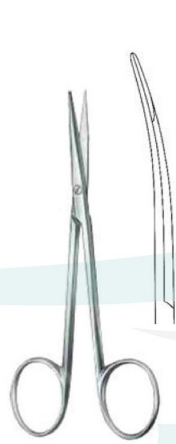

11 cm/4¼"

Straight	Curved
344.11	345.11

Vein graft scissors



SHEA
357.12
12 cm/4¾"



SANVENERO
14 cm/5½"

Straight	Curved
340.14	341.14

Nerve dissecting scissors

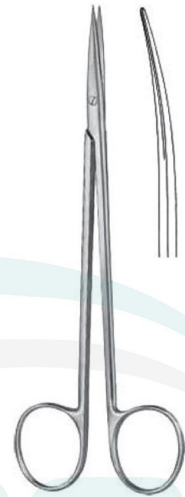

15.5 cm/6¼"

Straight	Curved
300.15	301.15

Dissecting scissors



CINELLI
317.11
11.5 cm/4½"



WERTHEIM
245.20
12 cm/4¾"



420.11
12 cm/4¾"



421.14
14 cm/5½"



422.15
14.5 cm/5¾"

Vascular scissors

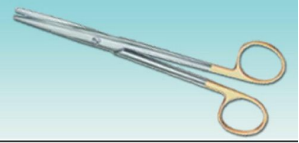

Scissors (Vascular Scissors, Dissecting Scissors)

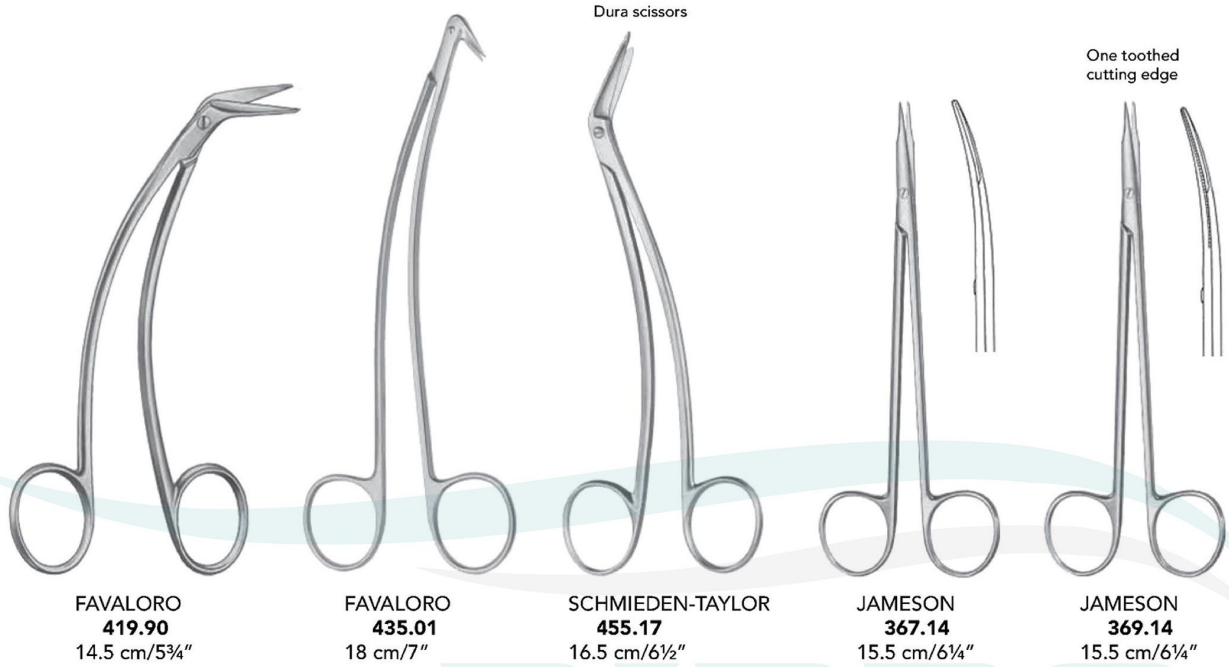

FAVALORO
419.90
14.5 cm/5¾"

FAVALORO
435.01
18 cm/7"

SCHMIEDEN-TAYLOR
455.17
16.5 cm/6½"

JAMESON
367.14
15.5 cm/6¼"

JAMESON
369.14
15.5 cm/6¼"

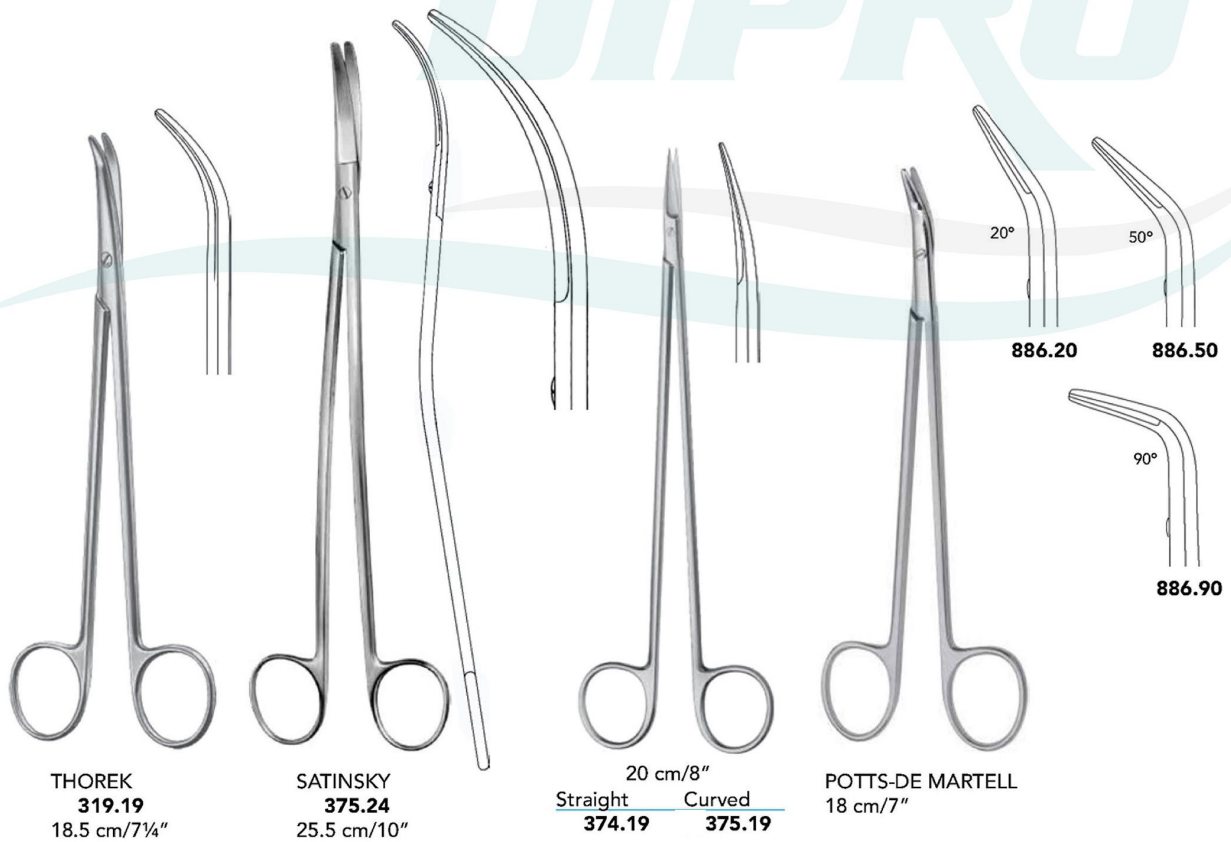

THOREK
319.19
18.5 cm/7¼"

SATINSKY
375.24
25.5 cm/10"

20 cm/8"
Straight **374.19** Curved **375.19**

POTTS-DE MARTELL
18 cm/7"

886.20

886.50

886.90

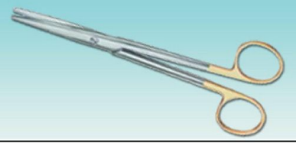

Scissors (Dissecting & Vascular Scissors)



DEBAKEY
17.5 cm/7" **315.17** **316.18**
20 cm/8" **315.20** **316.20**

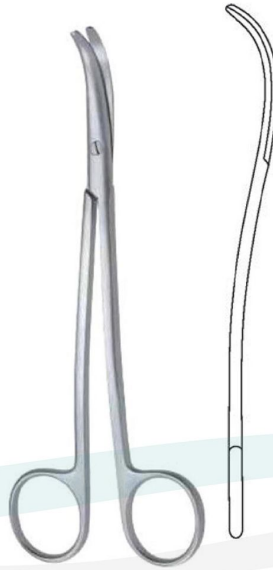

HOHENFELLNER
18 cm/7¼" **313.18** **314.18**
21 cm/8¼" **313.21** **314.21**
24 cm/9½" **313.24** **314.24**



LILLEHEI-POTTS
882.18
18 cm/7"

Neurosurgical scissors

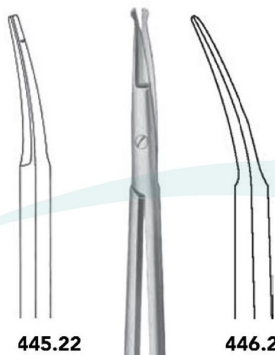

445.22

446.22

One serrated cutting edge

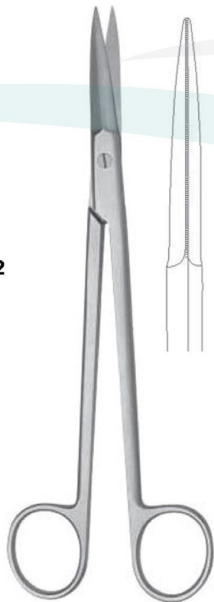

MCINDOE
480.19
18.5 cm/7¾"



STRULLY
22 cm/8¾"

Trigeminal scissors

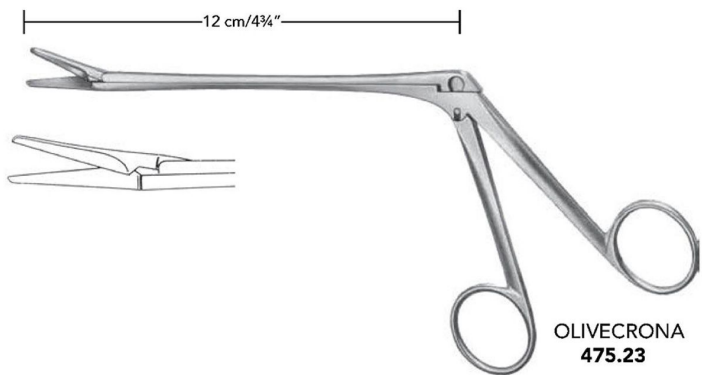

OLIVECRONA
475.23

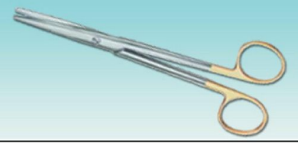

Scissors (Cornoary & Vascular Scissors)

One cutting edge with knife cut
for cleft palate



DIETRICH-SALYER
379.45
12 cm / 4¾"

10 mm



DIETRICH-HEGEMANN
18 cm / 7"

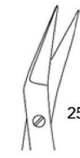

380.25

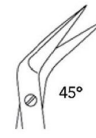

380.45

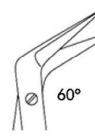

380.60

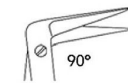
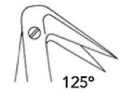

380.90

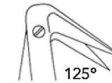

381.00

with guidance



DIETRICH
381.01
17.5 cm / 7"

10 mm



DIETRICH-HEGEMANN
18.5 cm / 7½"



427.25

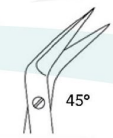

427.45

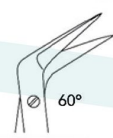

427.60



427.90



428.00

7 mm



MICRO-HEGEMANN
18.5 cm / 7½"



382.25



382.45



382.60



382.90

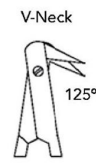

383.01

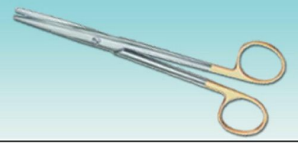

Scissors (Cornoary & Vascular Scissors)



POTTS-SMITH
18.5 cm/7½"

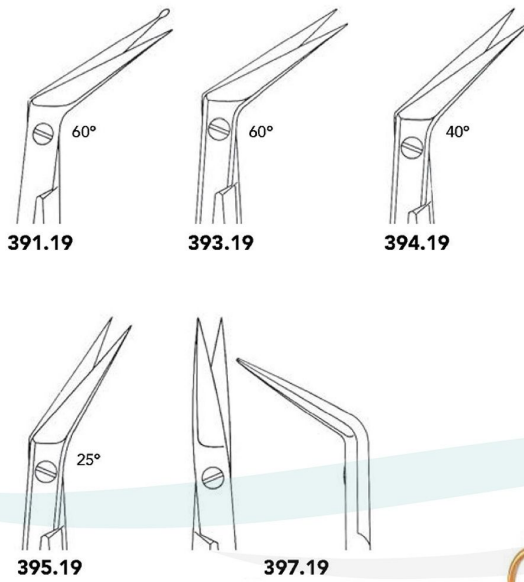

POTTS-SMITH
18.5 cm/7½"

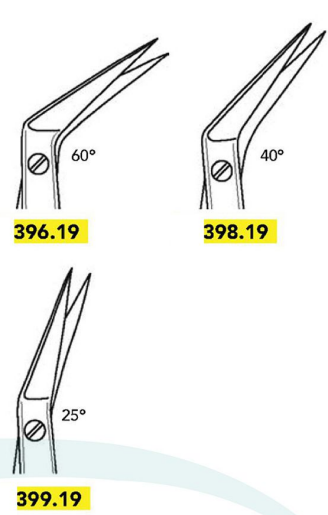

DEBAKEY
16 cm/6¼"

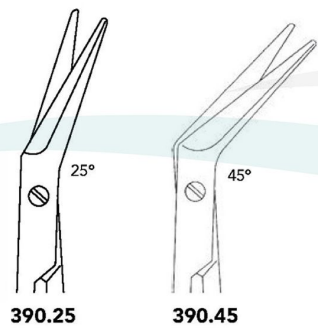

DEBAKEY

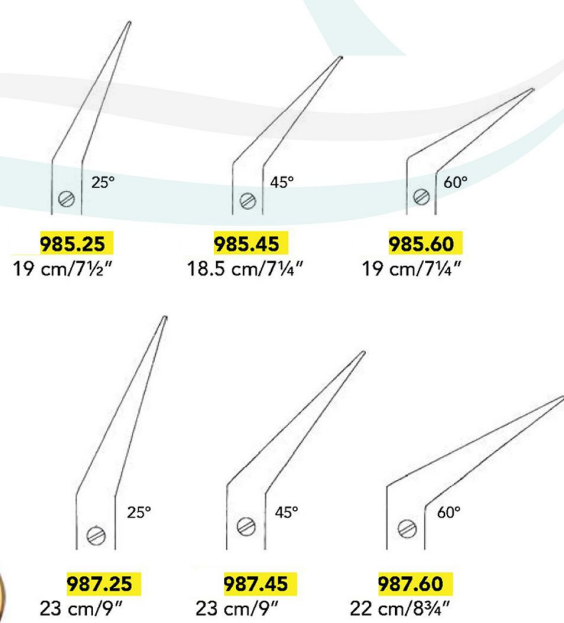

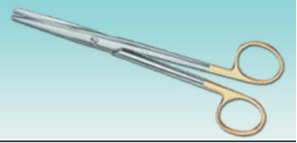

Scissors (Nasal & Gum Scissors)

One serrated cutting edge

TC Edge

Nasal Scissors

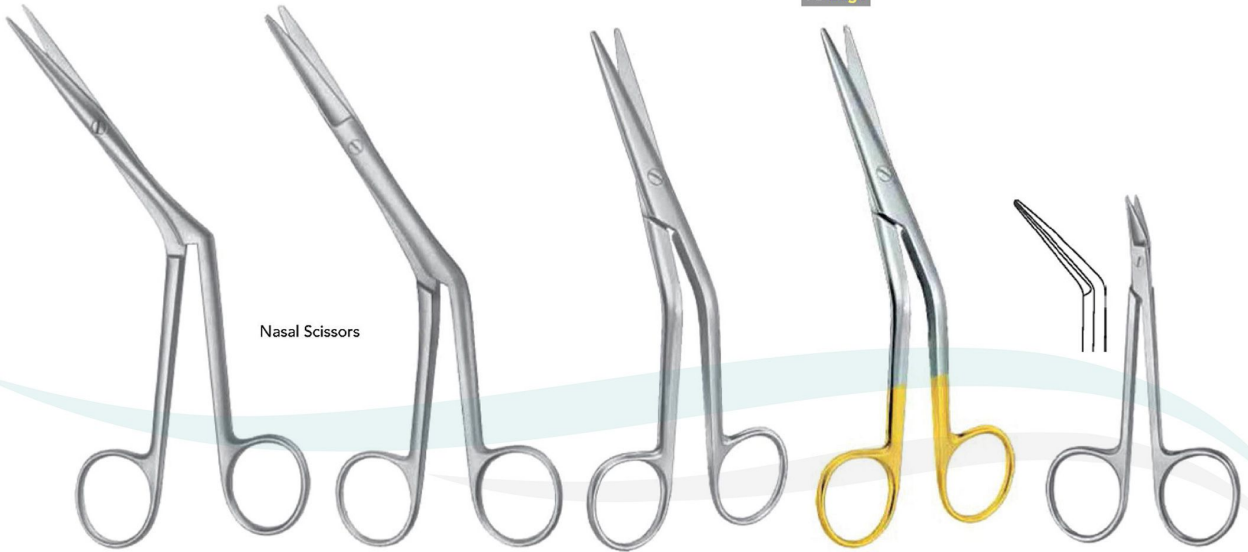

HEYMANN
511.18
18 cm/7"

HEYMANN
513.18
18 cm/7"

COTTLE
509.16
15.5 cm/6"

COTTLE
505.16
16 cm/6¼"

CONVERSE 10.5 cm/4¼"	
Sharp	Blunt
519.11	517.11

One toothed cutting edge

TC Edge



GOLDMAN-FOX 13 cm/5¼"	
Straight	Curved
566.13	567.13

GOLDMAN-FOX 13 cm/5¼"	
Straight	Curved
980.13	981.13

WAGNER 12 cm/4¾"	
Straight	Curved
570.12	571.12

12 cm/4¾"		
	Straight	Curved
Blunt/Blunt	580.12	585.12
Sharp/Blunt	582.12	587.12
Sharp/Sharp	584.12	589.12

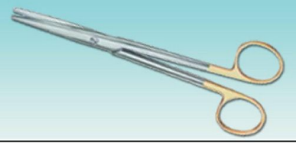

Scissors (Gum & Iris Scissors)

Extra delicate

9 cm/3½"		11.5 cm/4½"		11.5 cm/4½"		11.5 cm/4½"		11.5 cm/4½"	
Straight	Curved	633.11		Straight	Curved	IRIS 635.11		IRIS 989.11	
618.08	619.08	11.5 cm/4½"		690.11	691.11	11.5 cm/4½"		11.5 cm/4½"	

IRIS		IRIS 11.5 cm/4½"		IRIS 11.5 cm/4½"		11.5 cm/4½"	
Straight	Curved	Straight	Curved	Straight	Curved	Straight	Curved
9.0 cm/3½"	620.09	982.11	983.11	672.11	673.11	640.12	641.12
10.5 cm/3½"	620.10						
11.5 cm/4½"	620.11						
12.5 cm/5"	620.12						

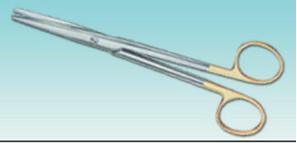

Scissors (Iris & Strabismus Scissors)



GRAEFE
637.10
10 cm/4"



LA GRANGE
593.11
11.5 cm/4½"



622.10
10.5 cm/4¼"



705.11
11.5 cm/4½"

DIPRO



STEVENS
11 cm/4¼"

Straight	Curved
680.11	681.11



STEVENS
11 cm/4¼"

Straight	Curved
674.11	675.11



STEVENS
11 cm/4¼"

Straight	Curved
682.11	683.11



STEVENS
11 cm/4¼"

Straight	Curved
676.11	677.11

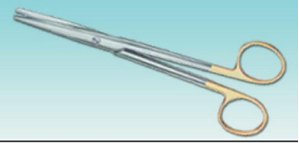

Scissors (Gynecological & Episiotomy Scissors)

TC Edge



SIMS

	Straight	Curved
20 cm/8"	200.20	203.20
23 cm/9"	200.23	203.23



SIMS

	Straight	Curved
20 cm/8"	976.20	977.20
23 cm/9"	976.23	977.23



SIMS-SIEBOLD

232.24
24 cm/9¾"



SIMS-SIEBOLD

233.24
24 cm/9¾"

One serrated cutting edge



WERTHEIM

	Curved
20 cm/8"	235.20
23 cm/9"	235.23



DOYEN
18 cm/7¼"

	Straight	Curved
230.17	231.17	



WALDMANN
531.18
18 cm/7"



BRAUN-STADLER
535.14
14.5 cm/5¾"



BRAUN-STADLER
537.22
20 cm

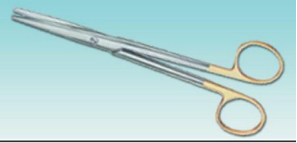

Scissors (Umbilical & Stitch Scissors, Dissecting Scissors)

Umbilical scissors



Mod.USA
545.10
10.5 cm/4¼"

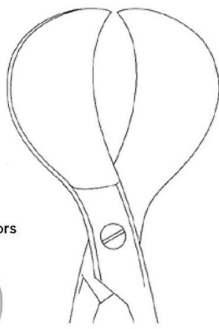

SCHUMACHER
547.16
15.5 cm/6"

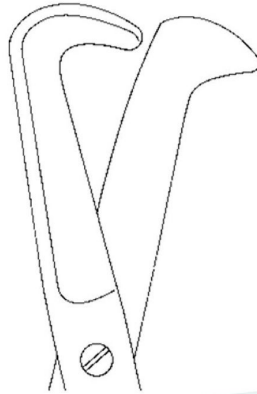

BUSCH
551.16
16 cm/6¼"



BUSCH
553.16
16 cm/6¼"

One toothed cutting edge



Stitch scissors



SPENCER
824.09
9 cm/3½"



SPENCER
826.13
13 cm/5"



LITTAUER
834.14
14 cm/5½"



FOMON
317.14
14.5 cm/5¾"

Dissecting scissors



RAGNELL
991.12
12.5 cm/5"

TC Edge

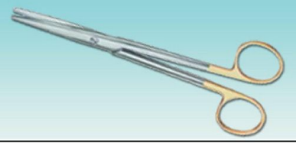

Scissors (Enterotomy & Rectal Scissors)

Rectal scissors

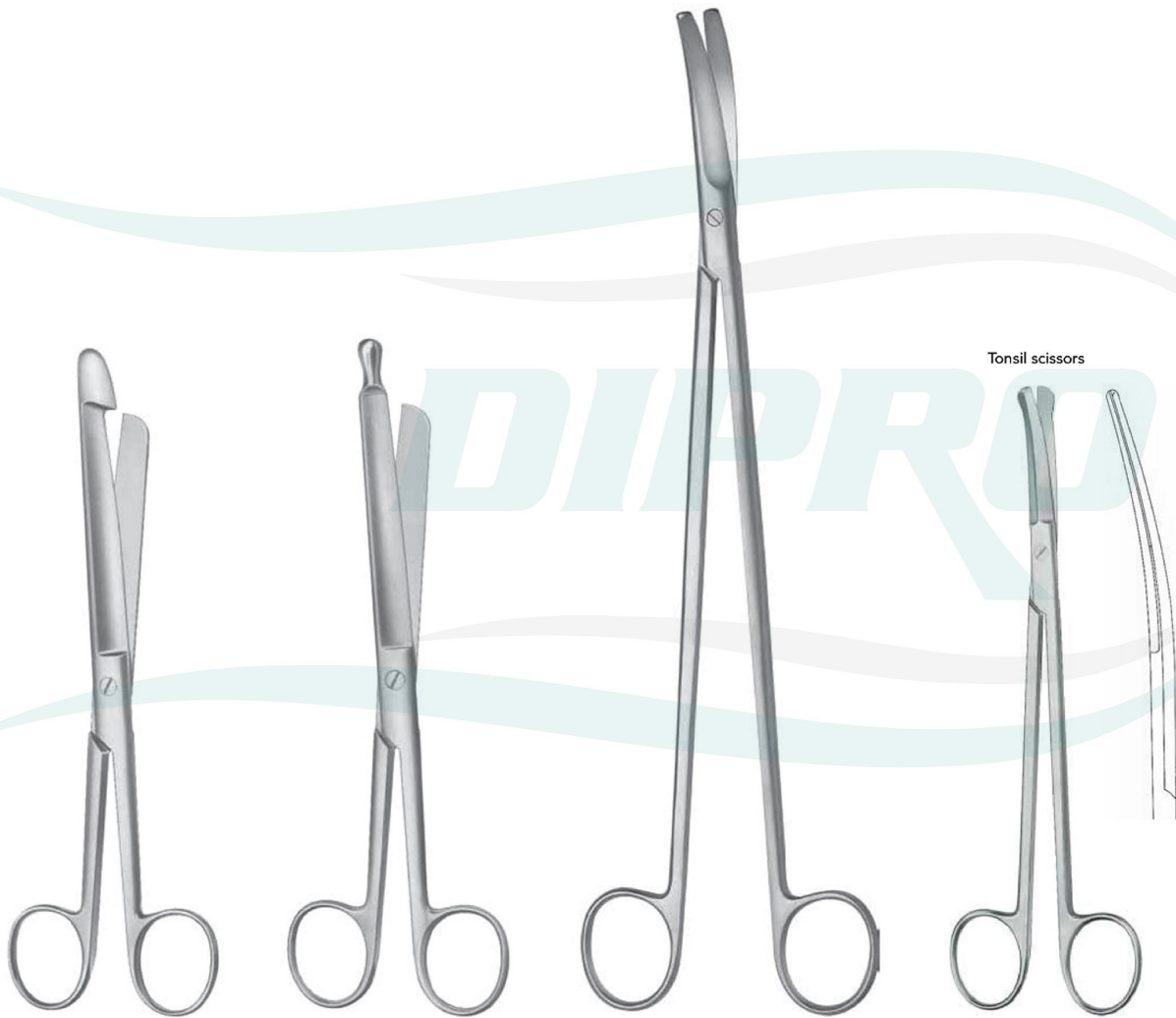

782.21
21.5 cm/8½"

784.21
21.5 cm/8½"

785.32
32.5 cm/13"

GOOD
499.19
19.5 cm/7¾"

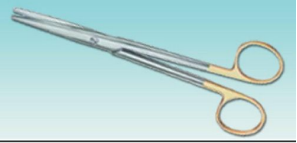

Scissors (Tonsil & Gum Scissors, Wire Cutting Scissors)

	TC Edge	One toothed cutting edge	One toothed cutting edge	One toothed cutting edge
DEAN 495.17 17.5 cm/7"	DEAN 994.17 17.5 cm/7"	DEAN 497.17 17.5 cm/7"	LOCKLIN 16 cm/5¼" 605.16 999.16	LOCKLIN 16 cm/5¼" 607.16 997.16

Wire cutting scissors		Wire cutting scissors	One toothed cutting edge
UNIVERSAL 865.12 12 cm/4¾"	UNIVERSAL 995.12 12 cm/4¾"	BEEBEE 10 cm/4" Straight Curved 874.10 875.10	BEEBEE 12 cm/4¾" Straight Curved 878.12 879.12

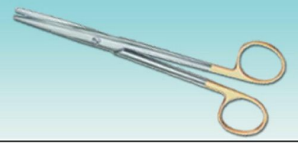

Scissors (Dissecting & Face-Lift Scissors)

for Cleft palate		for Cleft palate		Both cutting edges serrated	Sharp	Blunt
SALYER 784.09 9.5 cm/3¾"	SALYER 801.10 10 cm/3¾"	KAYE 809.11 11 cm/4¼"	PECK-JOSEPH 14.5 cm/5¾"	PECK-JOSEPH 14.5 cm/5¾"		
			Straight 352.14 Curved 353.14	Straight 354.14 Curved 355.14		

DIPRO

TC Edge
Toothed cutting edge

Toothed cutting edge

TC Edge
Toothed cutting edge

Toothed cutting edge			
GORNEY	GORNEY	KAYE	REES
Straight 306.12 12.5 cm/5" 19.5 cm/7¾" 17 cm/6¾"	Curved 307.19 970.19 20 cm/8" 23 cm/9" 970.23	305.00 18.5 cm/7½"	241.17 17 cm/7"

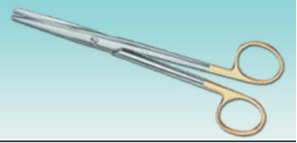

Scissors (Face-Lift Scissors)

Toothed cutting edge



GORNEY

		TC	SuperCut
18 cm/7"	Straight	110.18	120.18
18 cm/7"	Curved	111.18	121.18
23 cm/9"	Straight	110.23	120.23
23 cm/9"	Curved	111.23	121.23

Toothed cutting edge

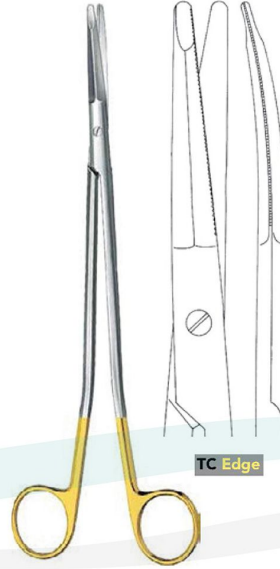

FREEMAN-GORNEY

		TC	SuperCut
	Straight	130.18	140.18
	Curved	131.18	141.18
	Straight	130.23	140.23
	Curved	131.23	141.23

Toothed cutting edge



**GREGORY
501.14**

14.5 cm/5¾"

Toothed cutting edge



KAYE

		TC	SuperCut
15 cm/6"		211.15	221.15
18 cm/7"		211.18	221.18
23 cm/9"		211.23	221.23

Toothed cutting edge



FREEMAN-KAYE

171.18
18 cm/7"

Toothed cutting edge



STELLA-S

505.18
18 cm/7"

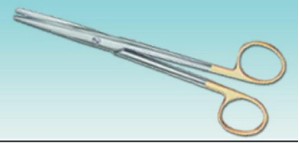

Scissors (Micro Scissors)



Streamlined

10 mm



	Adventitia Blades	Dissection Blades	Adventitia Serrated Blades	Dissection Serrated Blades
15 cm/6"	712.15	713.15	712.19	713.20
18 cm/7"	712.18	713.18		
21 cm/8¼"	712.21	713.21		
23 cm/9"	712.23	713.23		

DIPRO

10 mm



	Adventitia Blades	Dissection Blades	Adventitia Serrated Blades	Dissection Serrated Blades
15 cm/6"	710.15	711.15	710.19	711.20
18 cm/7"	710.18	711.18		
21 cm/8¼"	710.21	711.21		
23 cm/9"	710.23	711.23		

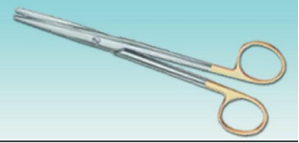

Scissors (Micro Scissors)



Streamlined

10 mm



	25°	45°	60°	90°	125°
18 cm/7"	400.25	400.45	400.60	400.90	401.00
21 cm/8¼"	384.25	384.45	384.60	384.90	385.00
23 cm/9"	398.25	398.45	398.60	398.90	399.00

7 mm



	25°	45°	60°	90°	125°
18 cm/7"	402.25	402.45	402.60	402.90	403.00

10 mm



	25°	45°	60°	90°	125°
18 cm/7"	412.25	412.45	412.60	412.90	413.00
21 cm/8¼"	436.25	436.45	436.60	436.90	437.00
23 cm/9"	438.25	438.45	438.60	438.90	439.00

7 mm



	25°	45°	60°	90°	125°
18 cm/7"	414.25	414.45	414.60	414.90	415.00

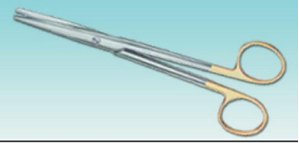

Scissors (Micro Scissors)



15 cm/6"

Adventitia
Blades



700.00

Dissection
Blades



701.00

9 mm

Adventitia
Serrated Blades



700.01

Dissection
Serrated Blades



701.01

14 mm

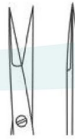

700.04



701.04



700.05



701.05



740.11



WESTCOTT
11.5 cm/4½"



741.11

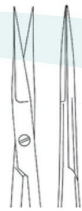

756.12



12 cm/4¾"



757.12



10 cm/4"



760.09



10 cm/4"



761.09

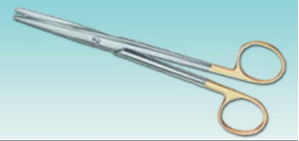

Scissors (Micro Scissors)

Vein scissors



VANNAS
12 cm/4¾"



850.01A

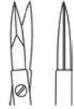

850.02A

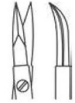

850.03



BIEMER
758.12
12 cm/4¾"



VANNAS
16 cm/6¼"

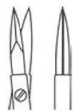

850.04A

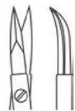

850.05



MILLESI
16 cm/6¼"



850.10A



850.11



850.15A



JACOBSON
18.5 cm/7¼"

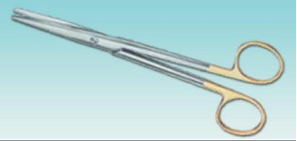

Scissors (Micro Scissors - Bayonet Shape)

Adventitia Blades

		Curved upwards	Curved downwards
16 cm/6¼"	850.16	851.16	
20 cm/8"	850.20A	851.20	853.20
22.5 cm/9"	850.22	851.22	
24 cm		850.24	



YASARGIL

Dissection Blades

		Curved upwards
20 cm/8"	854.20A	855.20A
22.5 cm/9"	854.22	855.22A

