

- EN Root Elevators
- DE Wurzelheber
- ES Elevadores para raíces

DIPRO



62

EN Root Elevators
 DE Wurzelheber
 ES Elevadores para raíces



FLOHR
 62.510.01
 Fig. 46



APICAL (Apexo)
 62.512.00
 Fig. 301



62.512.01
 Fig. 302



FLOHR
 62.512.02
 Fig. 303



62.512.03
 Fig. 304



MILLER
 62.520.03
 Fig. 8



MILLER
 62.520.04
 Fig. 9



MILLER (Apexo)
 62.520.01
 Fig. 10



MILLER (Apexo)
 62.520.02
 Fig. 11



CRYER
 62.525.05
 Fig. 3 A



SELDIN
 62.525.01
 Fig. 34



SELDIN
 62.525.02
 Fig. 34 S



SELDIN
 62.525.03
 Fig. 2



SELDIN
 62.525.04
 Fig. 3

62

EN Root Elevators
 DE Wurzelheber
 ES Elevadores para raíces



Apical Fragment Ejectors
 Wurzelspitzenheber
 Elevadores para fragmentos

Root tip teaser
 Wurzelspitzenheber
 Elevadores para fragmentos



HEIDBRINK
 62.560.01
 Fig. 1



62.560.02
 Fig. 2



62.560.03
 Fig. 3



HEIDBRINK



62.562.01
 Fig. 1



62.562.02
 Fig. 2



62.562.03
 Fig. 3

62

EN Root Elevators
DE Wurzelheber
ES Elevadores para raíces

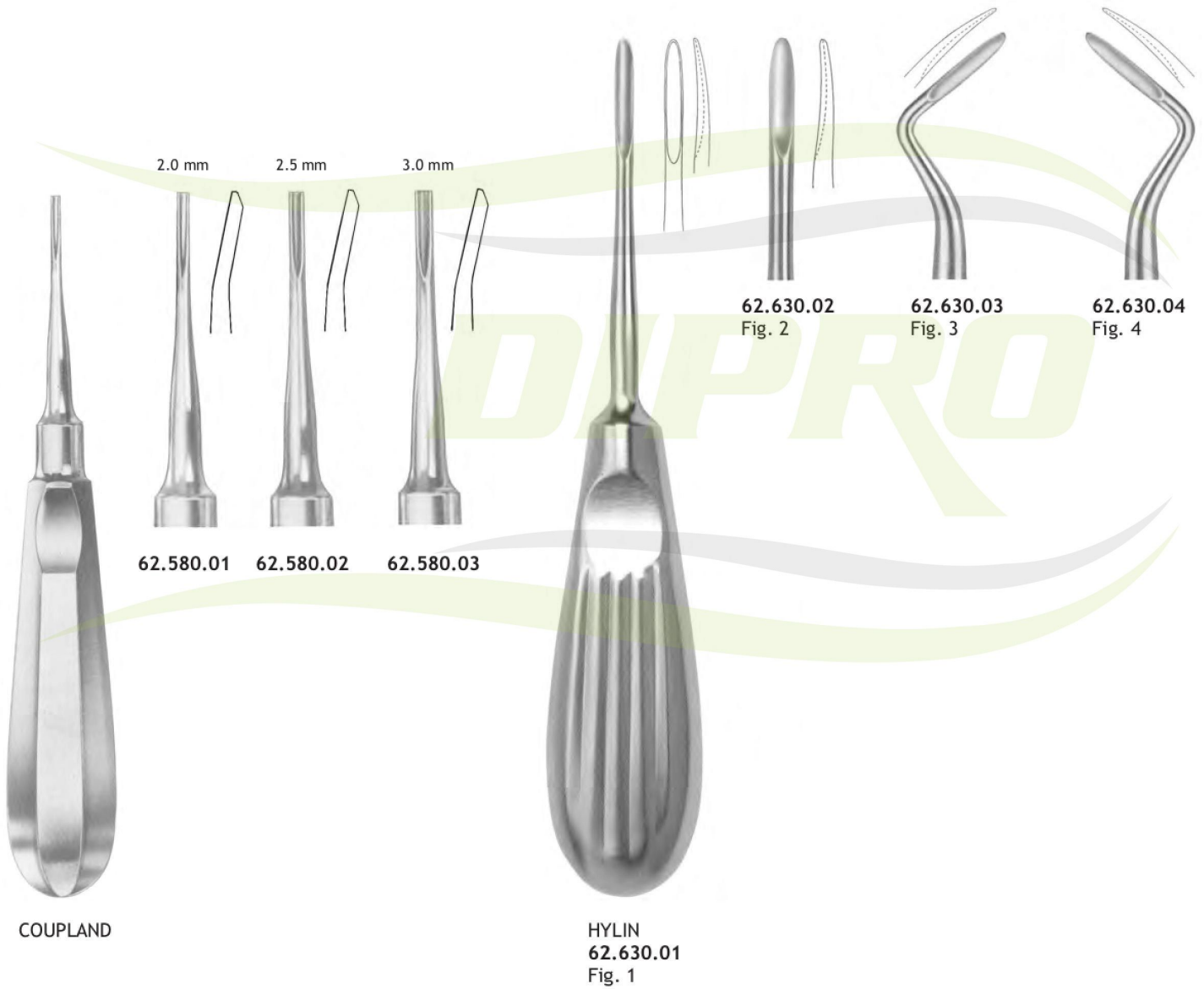

EN Root Elevators
 DE Wurzelheber
 ES Elevadores para raíces



KOPP



62.632.01
Fig. 1



62.632.02
Fig. 2



62.632.03
Fig. 3



62.632.04
Fig. 4



KOPP



62.633.01
Fig. 1



62.633.02
Fig. 2



62.633.03
Fig. 3



62.633.04
Fig. 4



RATZOW



62.634.01
Fig. 1



62.634.02
Fig. 2



62.634.03
Fig. 3

Apical Fragment Enucleators
 Wurzelspitzenausschäler
 Descorticadores de fragmentos

62

EN Root Elevators
DE Wurzelheber
ES Elevadores para raíces



EN Root Elevators
 DE Wurzelheber
 ES Elevadores para raíces

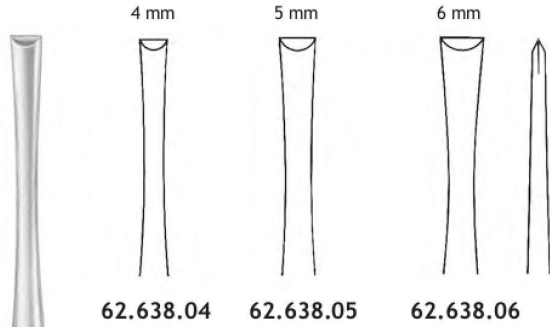

Apical Fragment Ejectors
 Wurzelspitzenheber
 Elevadores para fragmentos

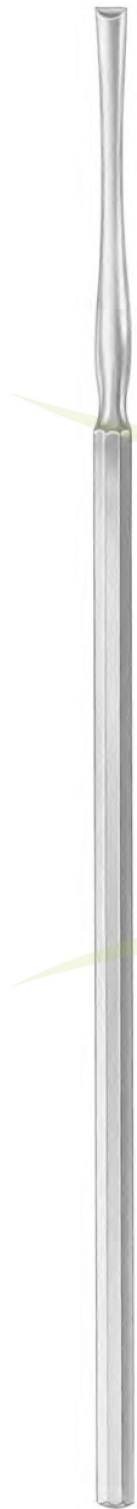

BARRY
 21,5 cm/8¾"

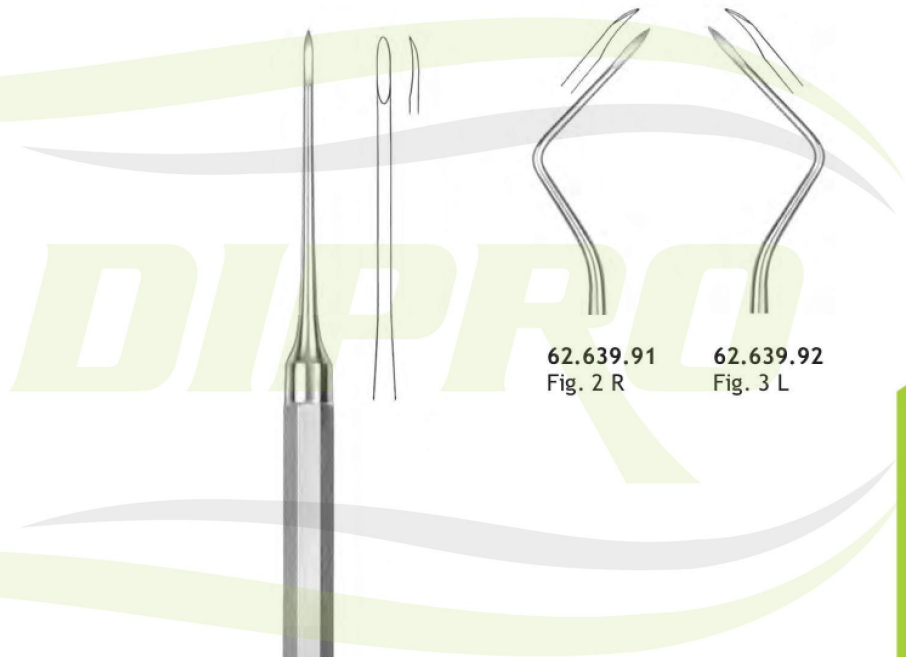

WEST (Apical)
 62.583.09
 Fig. 1



BERNARD



62.644.10
Fig. 0



62.644.01
Fig. 1



62.644.02
Fig. 2



62.644.06
Fig. 6



62.644.07
Fig. 7



62.644.11
Fig. 11

EN Syndesmotomes
 DE Syndesmotome
 ES Sindesmotomi



BERNARD
62.654.90

Flat handle
 Falchgriff
 Mango plano



62.654.01
 Fig. 1



62.654.02
 Fig. 2



62.654.03
 Fig. 3



62.654.04
 Fig. 4



62.654.05
 Fig. 5



62.654.10
 Fig. 10



62.654.06
 Fig. 6



62.654.07
 Fig. 7



62.654.08
 Fig. 8



62.654.09
 Fig. 9



62.654.11
 Fig. 11

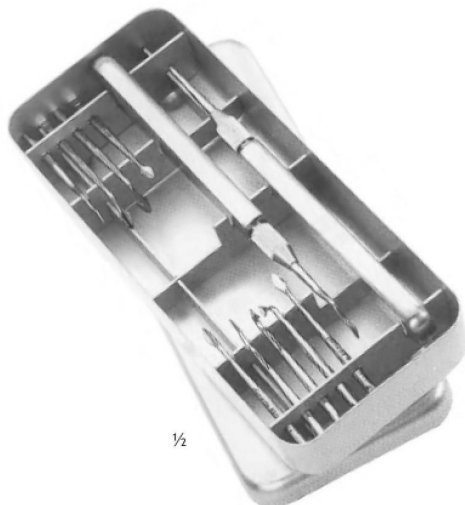

BERNARD
62.654.00

Set complete
 Satz komplett
 Juego completo

1/2

62

EN Root Elevators
 DE Wurzelheber
 ES Elevadores para raíces



WALTER F BARRY

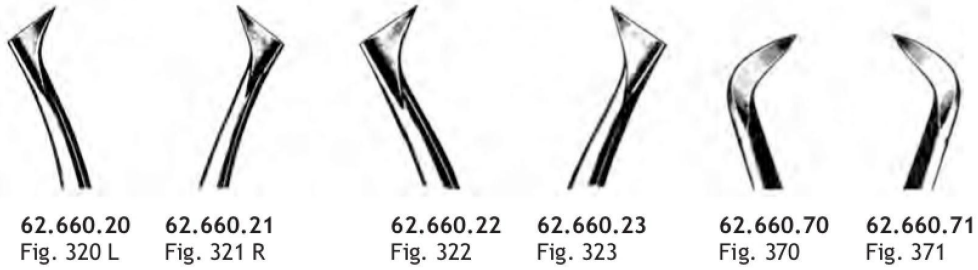

62.660.20
Fig. 320 L

62.660.21
Fig. 321 R

62.660.22
Fig. 322

62.660.23
Fig. 323

62.660.70
Fig. 370

62.660.71
Fig. 371



WALTER



62.665.01
Fig. 1 L

62.665.02
Fig. 1 R

62.666.01
Fig. 11 L

62.666.02
Fig. 11 R

62.667.01
Fig. 12 L

62.667.02
Fig. 12 R



62.668.01
Fig. 13 L

62.668.02
Fig. 13 R

62.669.01
Fig. 14 L

62.669.02
Fig. 14 R



62.670.01
Fig. 1



62.670.02
Fig. 2



62.671.01
Fig. 1



62.671.02
Fig. 2

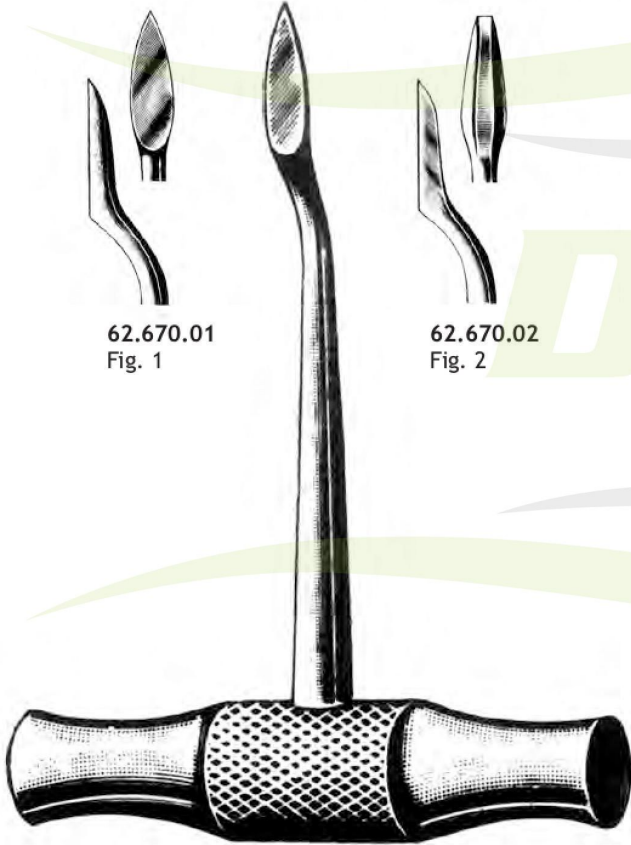

LECLUSE

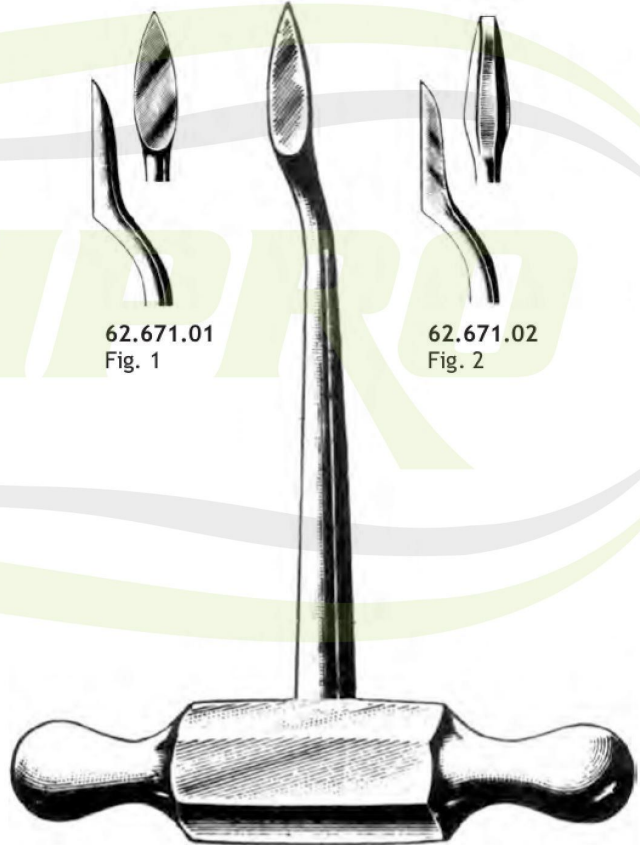

LECLUSE

62

EN Root Elevators
DE Wurzelheber
ES Elevadores para raíces

DIPRO **DIPROMED**
INSTRUMENTS

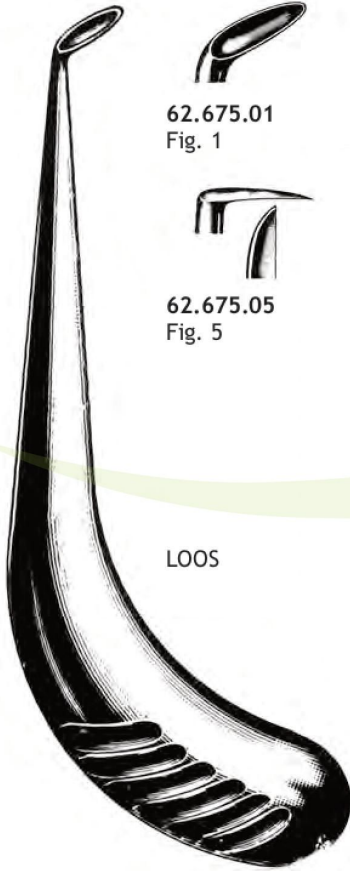

LOOS

62.675.01
Fig. 1



62.675.05
Fig. 5



62.675.02
Fig. 2



62.675.06
Fig. 6



KRALLENHEBER

62.677.01
Fig. 1 L



62.677.02
Fig. 2 R



POTT
15 cm/6"

62.680.01
Fig. 1



62.680.02
Fig. 2



EN Root Elevators
 DE Wurzelheber
 ES Elevadores para raíces



WARWICK-JAMES
 62.685.01
 Fig. 1



62.685.02
 Fig. 2



62.685.03
 Fig. 3



62.686.01
 Fig. 1



CHOMPRET
 62.686.02
 Fig. 2



62.686.03
 Fig. 3



FRIEDMAN
 62.695.01
 Fig. 1



62.695.02
 Fig. 2



62.695.03
 Fig. 3



FLOHR
 62.690.02
 Fig. 2



62.690.03
 Fig. 3



62.690.01
 Fig. 1

62

EN Cylinder cartridge syringe
 DE Zylinder-Ampullenspritze
 ES Jeringa para cartucho ampollas



DIPROMED

INSTRUMENTS



62.696.00 1,8 ml
 62.696.01 2,2 ml

with metric thread
 mit metrischem Gewinde
 con rosca métrica



62.696.02
 B



62.696.03
 C



62.698.00

62.698.01



62.700.00



62.700.01

Cannula LL, Only
 Kanüle LL, allein
 Cánula LL, suelta



62.761.18 1,8 ml
 62.761.22 2,2 ml

with metric thread
 mit metrischem Gewinde
 con rosca métrica



62.762.18 1,8 ml
 62.762.22 2,2 ml

EN Mouth Mirrors, Mouth mirror handles
 DE Mundspiegel, Mundspiegelgriffe
 ES Espejos de boca, Mangos para espejos de boca

with metric thread
 mit metrischem Gewinde
 con rosca métrica

Check retractor with handle
 Wangenabhalter mit Griff
 separador de la mejilla con mango

Back surface, plane
 Oberfläche Rückseite, plan
 Superficie del reerso, plano

Cone Socket
 with conical end of thread, plane
 mit konischem Gewindeauslauf, plan
 con terminal cónica de rosca, plano



62.702.16 1 = 16 mm
 62.702.20 3 = 20 mm
 62.702.22 4 = 22 mm
 62.702.24 5 = 24 mm



62.704.20 3 = 20 mm
 62.704.22 4 = 22 mm
 62.704.24 5 = 24 mm



62.715.01
 4,5 cm/1¾"

62.715.02

Griffe
 Handle
 Mango

HILGER
 62.715.00
 18 cm/7"

62

EN Mouth mirror handles
DE Mundspiegelgriffe
ES Mangos para espejos de boca

DIPRO **DIPROMED**
INSTRUMENTS

Cone Socket
Konishem-Stiel

Cone Socket
Konishem-Stiel



62.721.01
14 cm/5½"



62.721.04
13,5 cm/5¼"



62.722.01
14 cm/5½"



62.723.01
12.5 cm/5"



62.726.01
12 cm/4¾"



62.728.01
12 cm/4¾"



62.730.01

Ergo, Modell
Ergo, Model
Ergo, Módulo