

**Rhinology (Nasal Speculas)**

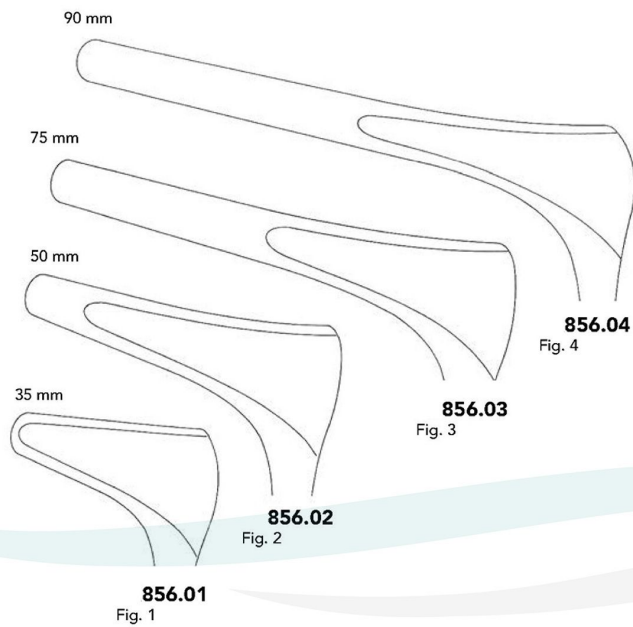

**KILLIAN**  
14 cm/5½"



**856.01**  
Fig. 1

**856.02**  
Fig. 2

**856.03**  
Fig. 3

**856.04**  
Fig. 4



**HARTMANN-HALLE**  
14 cm/5½"

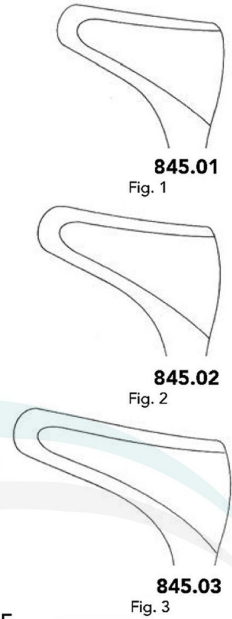

**845.01**  
Fig. 1

**845.02**  
Fig. 2

**845.03**  
Fig. 3



**COTTLE**  
15 cm/6"

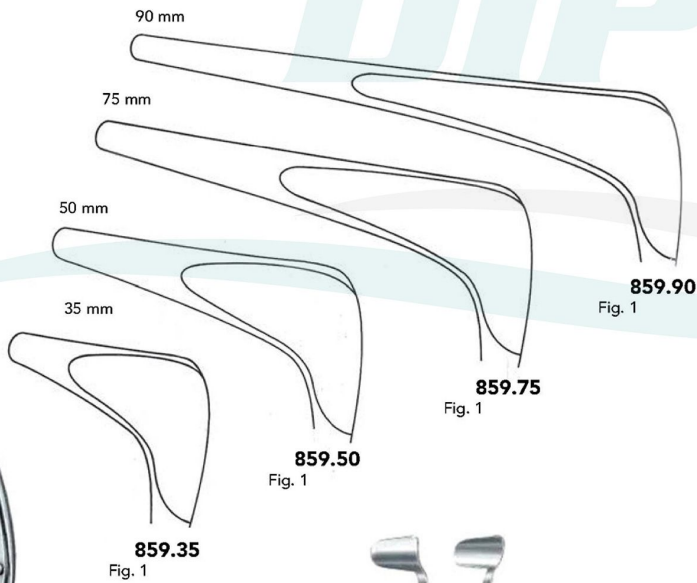

**859.35**  
Fig. 1

**859.50**  
Fig. 1

**859.75**  
Fig. 1

**859.90**  
Fig. 1



**GOLDSMITH-THUDICHUM**  
Fig. Blades 6.5 cm/2½"

1	18.5 x 9.5 mm	<b>817.01</b>
2	21.0 x 10.5 mm	<b>817.02</b>
3	21.0 x 11.5 mm	<b>817.03</b>



**TIECK-HALLE**  
**852.13**  
13 cm/5"



**VIENNA**  
**858.14**  
14 cm/5½"



**Rhinology (Nasal Speculums)**

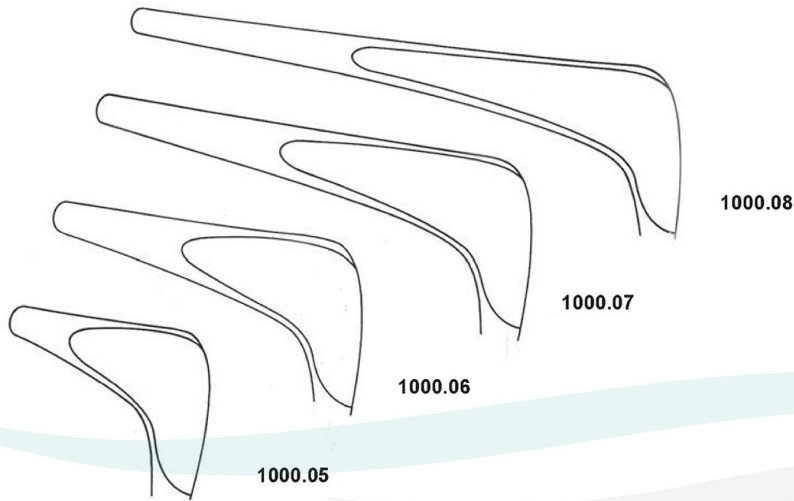

**COTTLE**  
13.5 cm

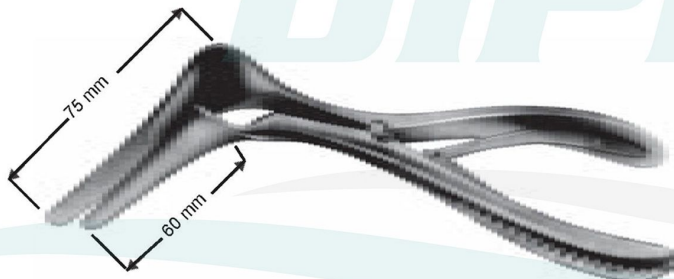

**1000.09**  
Kisa sol bleyd,  
Left blade shortened

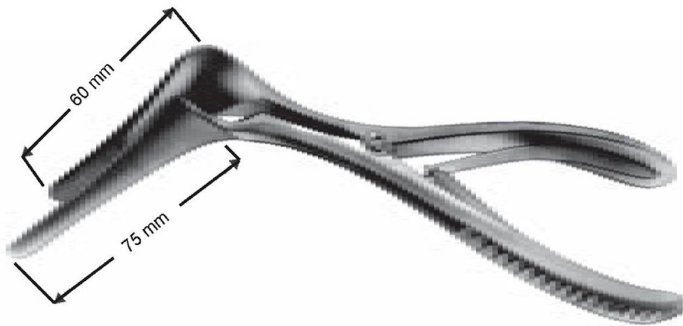

**1000.10**  
Kisa sağ bleyd,  
Right blade shortened

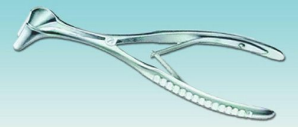

**Rhinology (Nasal Tempon & Septum Forceps)**

1:2  
115.16  
16 cm/6¼"



GRUENWALD (JANSEN)  
115.20  
21.5 cm/8½"

TROELTSCH  
105.18  
15.5 cm/6"



TROELTSCH  
101.15  
14.5 cm/5¾"



WESTMACOTT  
121.20  
20 cm/8"



Nasal Polypus  
Forceps

LUBET-BARBON  
129.20  
18.5 cm/7¼"



HARTMANN  
145.20  
18.5 cm/7¼"



KNIGHT  
207.18  
17 cm/6¾"

GRAIG  
213.18  
16 cm/6¼"

KNIGHT  
15.5 cm/6"  
215.01 left curved  
215.02 right curved

BRUENINGS  
16.5 cm/6½"  
Fig. 1 227.01  
Fig. 2 227.02  
Fig. 3 227.03  
Fig. 4 227.04

LUC  
1000.01- 1000.02  
20 cm



**Rhinology (Ethmoid Bone Forceps, Nasal Cutting Forceps)**

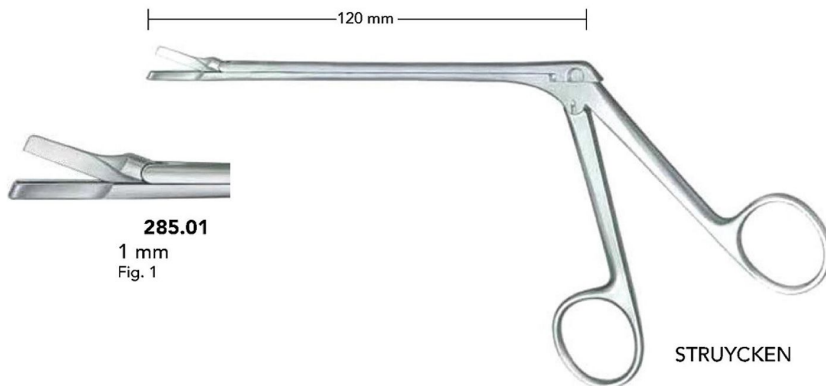
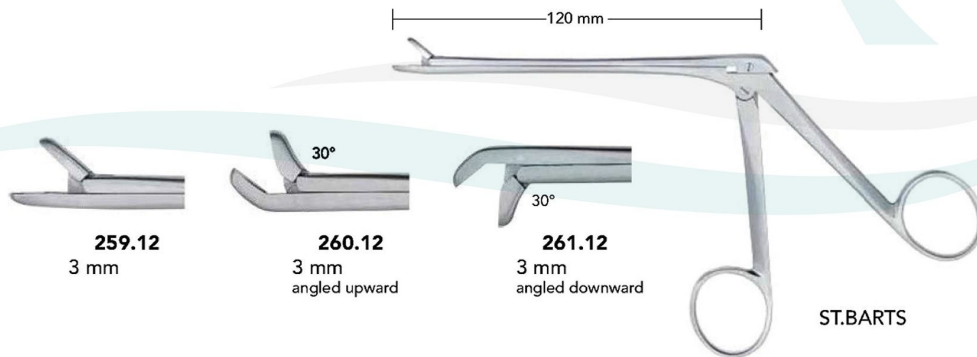
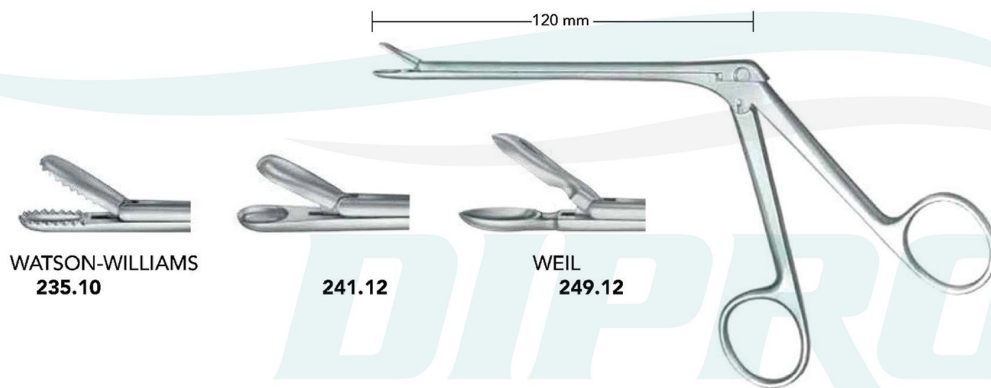
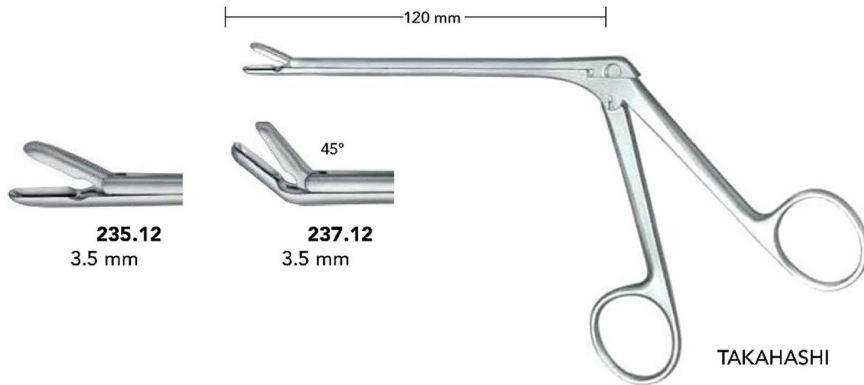

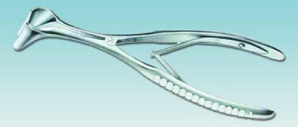

**Rhinology (Nasal Cutting Forceps, Antrum Punches)**

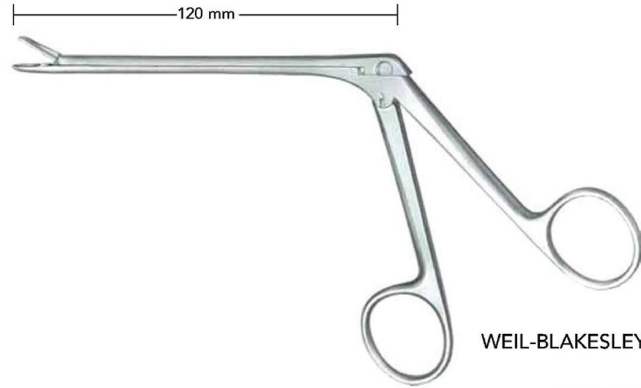

WEIL-BLAKESLEY

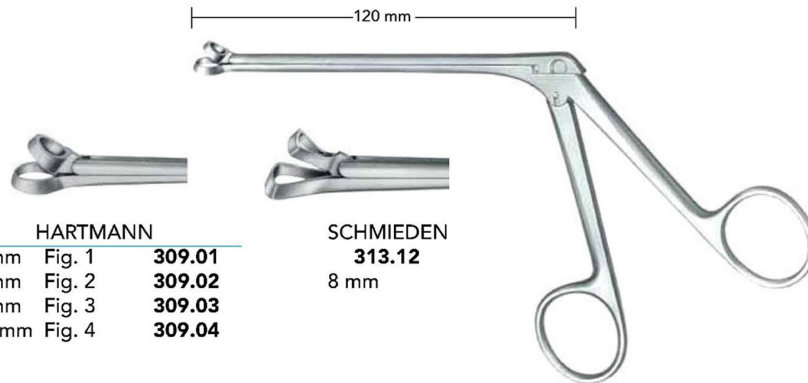
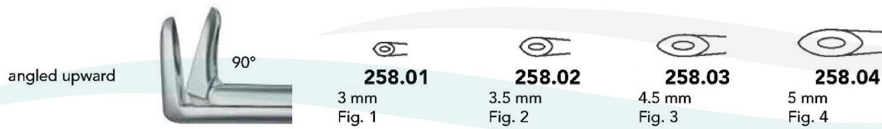
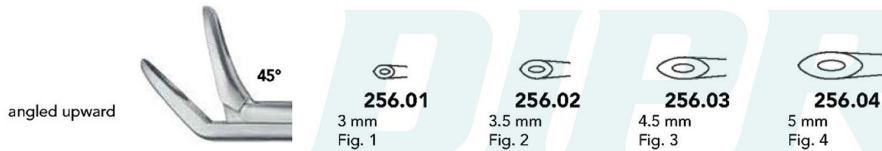

HARTMANN		
Ø 5 mm	Fig. 1	<b>309.01</b>
Ø 7 mm	Fig. 2	<b>309.02</b>
Ø 9 mm	Fig. 3	<b>309.03</b>
Ø 11 mm	Fig. 4	<b>309.04</b>

**SCHMIEDEN**  
**313.12**  
8 mm



**Rhinology (Sphenoid Bone Punches, Antrum Punches)**

	90° upward cutting	90° downward cutting	40° downward cutting
3 mm	<b>356.17</b>	<b>357.17</b>	<b>362.03</b>
5 mm	<b>360.17</b>	<b>361.17</b>	<b>362.05</b>

**FERRIS-SMITH-KERRISON**

	straight	30° angled upward	30° angled downward
10 x 2 mm	<b>364.02</b>	<b>365.02</b>	<b>367.02</b>
10 x 3 mm	<b>364.03</b>	<b>365.03</b>	<b>367.03</b>
10 x 4 mm	<b>364.04</b>	<b>365.04</b>	<b>367.04</b>
10 x 5 mm	<b>364.05</b>	<b>365.05</b>	<b>367.05</b>
10 x 6 mm	<b>364.06</b>	<b>365.06</b>	<b>367.06</b>

	90° upward cutting	90° downward cutting
3.5 mm	<b>342.12</b>	
4 mm		<b>343.12</b>

**KERRISON**

**HAJEK**

	<b>KERRISON</b>
3 x 3 mm	<b>389.00</b>
4 x 4 mm	<b>389.01</b>
5 x 5 mm	<b>389.02</b>
6 x 6 mm	<b>389.03</b>

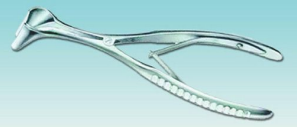

**Rhinology** (Septum Forceps, Septum Morselizers)

through-cutting



MIDDLETON-JANSEN  
**323.19**  
20.5 cm/8¼"

one toothed cutting edge



MIDDLETON-JANSEN  
**327.19**  
20 cm/8"

TC Jaws



CAPLAN  
**331.20**  
20 cm/8"



**334.21**  
20 cm/8"



RUBIN  
**335.20**  
20 cm/8"



RUBIN  
**335.21**  
18.5 cm/7¼"

TC Jaws



RUBIN  
**337.21**  
18.5 cm/7¼"







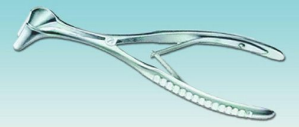

Protection Cap









**335.01**



**Rhinology (Rhinoplasty & Septum Knives, Swivel Knives)**







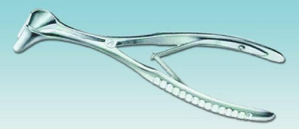







							
JOSEPH 15 cm/6"	FOMON 444.16 16.5 cm/6½"	CONVERSE 459.16 16 cm/6¼"	JOSEPH 466.15 15.5 cm/6"	COTTLE 468.15 14 cm/5½"	Mucosa Knife FREER 484.15 16.5 cm/6½"	FREER 497.19 19 cm/7½"	FREER 499.19 18.5 cm/7¼"
Fig. 1 <b>440.01</b> Fig. 2 <b>440.02</b>							

					
BALLENGER 21 cm/8¼"	BALLENGER 21 cm/8¼"	MCKENTY 15 cm/6"	HALLE 525.16 16 cm/6¼"	JOSEPH 531.16 16.5 cm/6½"	Cleft Palate Periosteal Raspatory 544.01 24.5 cm/9½"
3 mm <b>504.03</b> 4 mm <b>504.04</b> 5 mm <b>504.05</b>	3 mm <b>505.03</b> 4 mm <b>505.04</b> 5 mm <b>505.05</b>	4 mm <b>521.04</b> 5 mm <b>521.05</b>	3.5 mm	4 mm	544.02 24.5 cm/9½"
			Septum Elevators	Septum Elevators	





**Rhinology (Septum Elevators, Periosteal Elevators)**

5 mm	sharp/blunt		5 mm	5 mm	5 mm	5 mm	4 mm	6 mm	5.5 mm
									
<b>FREER</b> 19 cm/7½"	<b>FREER</b> 18 cm/7"	<b>FREER</b> 18 cm/7"	<b>FREER</b> 21 cm/8¼"	<b>MCKENTY</b> 20.5 cm/8"	<b>BALLENGER-HAJEK</b> 19 cm/7½"	<b>HOWARD</b> 21.5 cm/8½"			
sharp <b>541.19</b> blunt <b>543.19</b>	<b>545.18</b>	<b>547.18</b>	<b>547.20</b>	<b>549.22</b>	<b>550.19</b>	<b>557.22</b>			
5 mm	4 mm	4.5 mm	4 mm	4 mm	3.3 mm	4.5 mm	6.5 mm		
									
<b>COTTLE</b> 23.5 cm/9¼"	<b>KILLIAN</b> 18 cm/7"	<b>KILLIAN</b> 23.5 cm/9¼"	<b>PENNINGTON</b> 21 cm/8"	<b>JOSEPH-MASING</b> 21.5 cm/8½"	<b>COTTLE</b> 23 cm/9"	<b>COTTLE</b> 23 cm/9"	<b>JOSEPH</b> 18 cm/7"		
<b>559.23</b>	<b>560.18</b>	<b>562.22</b>	<b>568.21</b>	<b>579.22</b>	<b>581.22</b>	<b>585.22</b>	<b>585.16</b>		



**Rhinology** (Septum Elevators, Periosteal Elevators)



**FREER**  
**593.16**  
16.5 cm/6½"



**FREER**  
**595.15**  
16 cm/6¼"



**BALLENGER**  
15 cm/6"  
2 mm **597.02**  
4 mm **597.04**  
6 mm **597.06**  
8 mm **597.08**



**KILLIAN**  
**601.16**  
16 cm/6¼"



**KILLIAN-CLAUS**  
**605.16**  
16 cm/6¼"



**COTTLE**  
18.5 cm/7¼"  
4 mm **606.04**  
7 mm **606.07**  
9 mm **606.09**  
12 mm **606.12**



**COTTLE**  
18.5 cm/7¼"  
2 mm **608.02**  
4 mm **608.04**  
7 mm **608.07**  
9 mm **608.09**  
12 mm **608.12**

6 mm



**COTTLE**  
**607.06**  
18.5 cm/7¼"

6 mm



**COTTLE**  
**609.06**  
18.5 cm/7¼"

16 mm



**COTTLE**  
**610.16**  
18.5 cm/7¼"

16 mm



**COTTLE**  
**612.16**  
18.5 cm/7¼"



**RUBIN**  
18.5 cm/7¼"  
10 mm **616.10**  
12 mm **616.12**  
14 mm **616.14**



**WALTER**  
19 cm/7½"  
3.0 mm **620.03**  
4.5 mm **620.04**



**WALTER**  
19 cm/7½"  
3 mm **622.03**  
4 mm **622.04**  
7 mm **622.07**  
9 mm **622.09**  
12 mm **622.12**

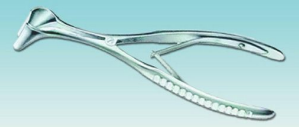







**Rhinology (Rhinoplasty Chisels, Chisels)**

<b>FOMON</b> 16 cm/6¼"		<b>CINELLI</b> 16 cm/6¼"		<b>NEIVERT-ANDERSON</b> 20.5 cm/8"		<b>LUCAS</b> 16 cm		<b>SILVER</b> 18 cm/7"		<b>SILVER</b> 18 cm/7"		<b>SILVER</b> 18 cm/7"	
4 mm	<b>623.04</b>	10 mm	<b>624.10</b>	7 mm	<b>625.01</b>	3 mm	<b>1000.02</b>	18 cm/7"	18 cm/7"	18 cm/7"	18 cm/7"	18 cm/7"	18 cm/7"
5 mm	<b>623.05</b>	12 mm	<b>624.12</b>	7 mm	<b>625.02</b>	5 mm	<b>1000.03</b>	18 cm/7"	18 cm/7"	18 cm/7"	18 cm/7"	18 cm/7"	18 cm/7"
6 mm	<b>623.06</b>	14 mm	<b>624.14</b>	7 mm	<b>625.03</b>	Gujjar/Gouges		18 cm/7"	18 cm/7"	18 cm/7"	18 cm/7"	18 cm/7"	18 cm/7"
7 mm	<b>623.07</b>	16 mm	<b>624.16</b>	Straight				18 cm/7"	18 cm/7"	18 cm/7"	18 cm/7"	18 cm/7"	18 cm/7"

<b>PARKES</b> 16 cm/6¼"		<b>JOSEPH</b> 17 cm/6¾"		<b>JOSEPH</b> 17 cm/6¾"		<b>JOSEPH</b> 19 cm/7½"		<b>JOSEPH</b> 40 mm working length		<b>JOSEPH</b> 40 mm working length		<b>JOSEPH</b> 40 mm working length	
	<b>629.01</b>	angled, left	<b>632.20</b>	angled, right	<b>634.20</b>		<b>634.20</b>	angled, left	<b>649.00</b>	angled, left	<b>649.01</b>	angled, right	<b>649.02</b>



**Rhinology (Nasal Raspers, Bone Files, Antrum Raspers)**

<p>34 x 7 mm</p>  <p><b>MALTZ</b> 17 cm/6¾"</p> <p>drawing cut <b>656.01</b> pushing cut <b>656.02</b></p>	<p>60 x 8 mm</p>  <p><b>JOSEPH</b> <b>658.01</b></p> <p>16 cm/6¼"</p>	<p>45 x 6 mm</p>  <p><b>GALLAHER</b> 17 cm/6¾"</p>	<p>45 x 6 mm</p>  <p><b>669.01</b> 45 x 6 mm</p>	<p>45 x 6 mm</p>  <p><b>669.02</b> 45 x 6 mm</p>	<p>45 x 6 mm</p>  <p><b>669.03</b> 45 x 6 mm</p>	<p>34 x 8 mm</p>  <p><b>COTTLE</b> <b>670.21</b></p> <p>21 cm/8¼"</p>
<p>Cartilage Crusher</p> 						
<p>32 x 9 mm</p>  <p><b>AUFRICHT</b> 21 cm/8¼"</p> <p>drawing cut <b>671.21</b> pushing cut <b>673.21</b></p>	<p>15 x 8 mm</p>  <p><b>LEWIS</b> 19 cm/7½"</p> <p>drawing cut <b>674.18</b> pushing cut <b>676.18</b></p>	<p><b>FOMON</b> <b>680.21</b></p> <p>20.5 cm/8"</p> 	<p>6.5 mm</p>  <p><b>FOMON</b> <b>1000.03</b></p> <p>21.5 cm</p>	<p>6.5 mm</p>  <p><b>FOMON</b> <b>1000.04</b></p> <p>21.5 cm</p>	<p>6.5 mm</p> 	<p>6.5 mm</p> 

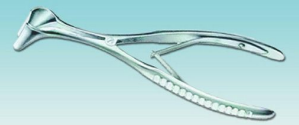

**Rhinology (Nasal Raspas - TC Jaws)**



**MALTZ**  
21 cm/8¼"

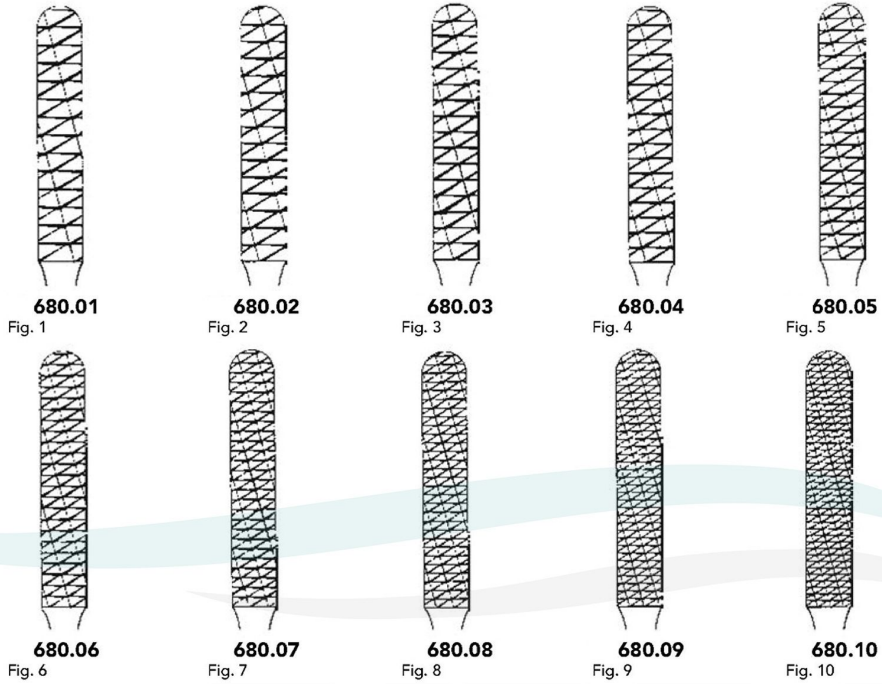

TC Jaws

TC Jaws

TC Jaws



**FOMON**  
20.5 cm/8"

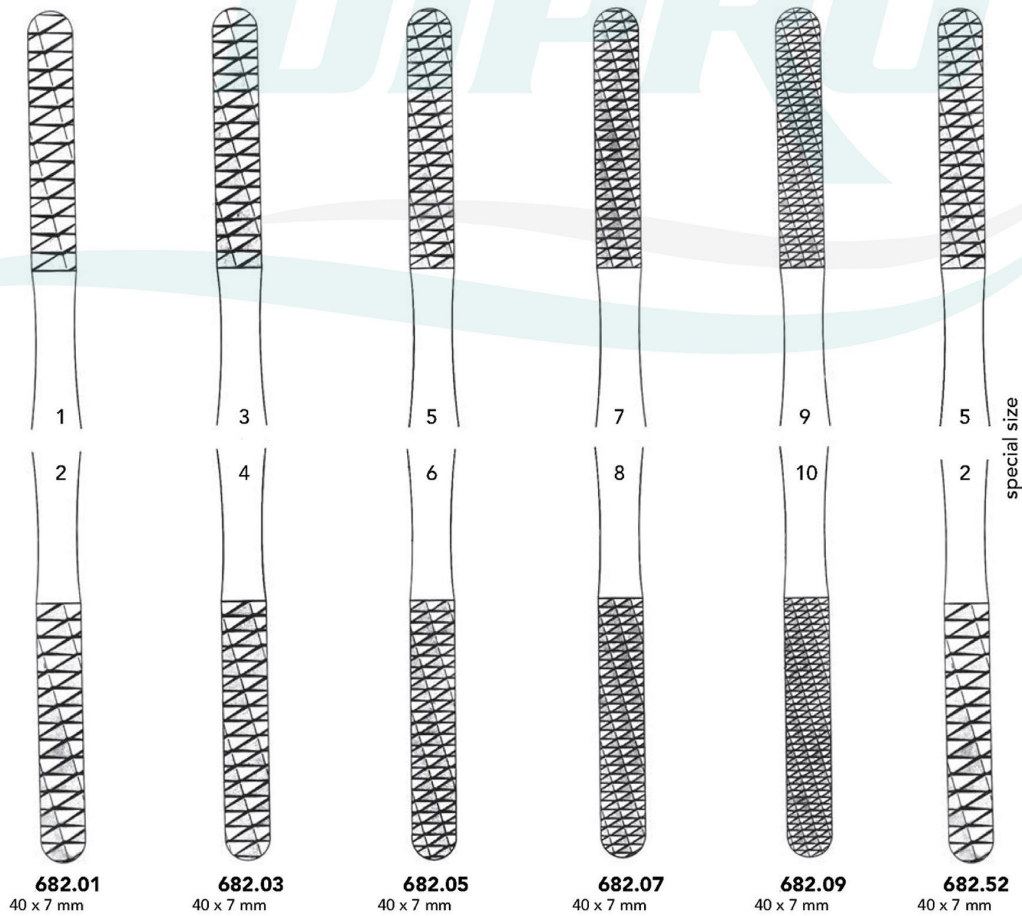

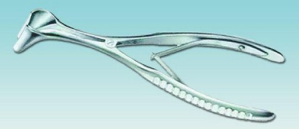

**Rhinology (Nasal Hooklets, Alar & Mucosa Hooklet)**

Alar Hooklet, button end

Mucosa Hooklet, sharp

sharp

sharp

Alar Hooklet, button end

45 x 11 mm

sharp

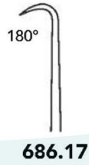

**JOSEPH**  
**684.15**  
15.5 cm/6"

**COTTLE**  
17 cm/6¾"

**COTTLE**  
17 cm/6¾"

**LANGE**  
**692.22**  
23 cm/9"

**FOMON**  
**694.17**  
17 cm/6¾"

**AUFRICHT**  
**697.19**  
19 cm/7½"

**KILNER**  
**698.10**  
8 cm/3¼"

button end

44 x 11 mm



**CONVERSE**  
**699.11**  
10.5 cm/4¼"

**CONVERSE**  
**700.12**  
11.5 cm/4½"

**FREER**  
**702.15**  
15 cm/6"

**JOSEPH**  
16 cm/6¼"  
2 mm **704.02**  
5 mm **704.05**  
7 mm **704.07**  
10 mm **704.10**

**FOMON**  
**706.16**  
16 cm/6¼"

**COTTLE-NEIVERT**  
**707.20**  
19.5 cm/7¾"

**COTTLE**  
19.5 cm/7¾"

**708.14**  
sharp

**709.01**  
blunt/sharp

**709.02**  
sharp/blunt

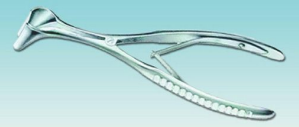

**Rhinology (Nasal Retractors)**

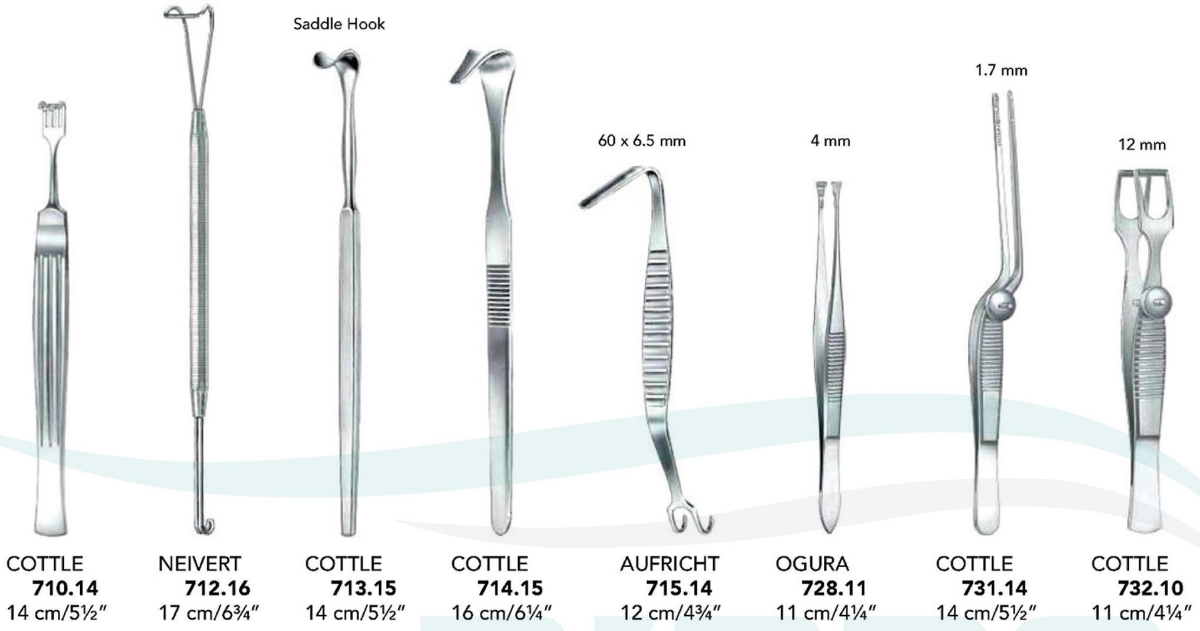

**COTTLE 710.14** 14 cm/5½"  
**NEIVERT 712.16** 17 cm/6¾"  
**COTTLE 713.15** 14 cm/5½"  
**COTTLE 714.15** 16 cm/6¼"  
**AUFRICHT 715.14** 12 cm/4¾"  
**OGURA 728.11** 11 cm/4¼"  
**COTTLE 731.14** 14 cm/5½"  
**COTTLE 732.10** 11 cm/4¼"

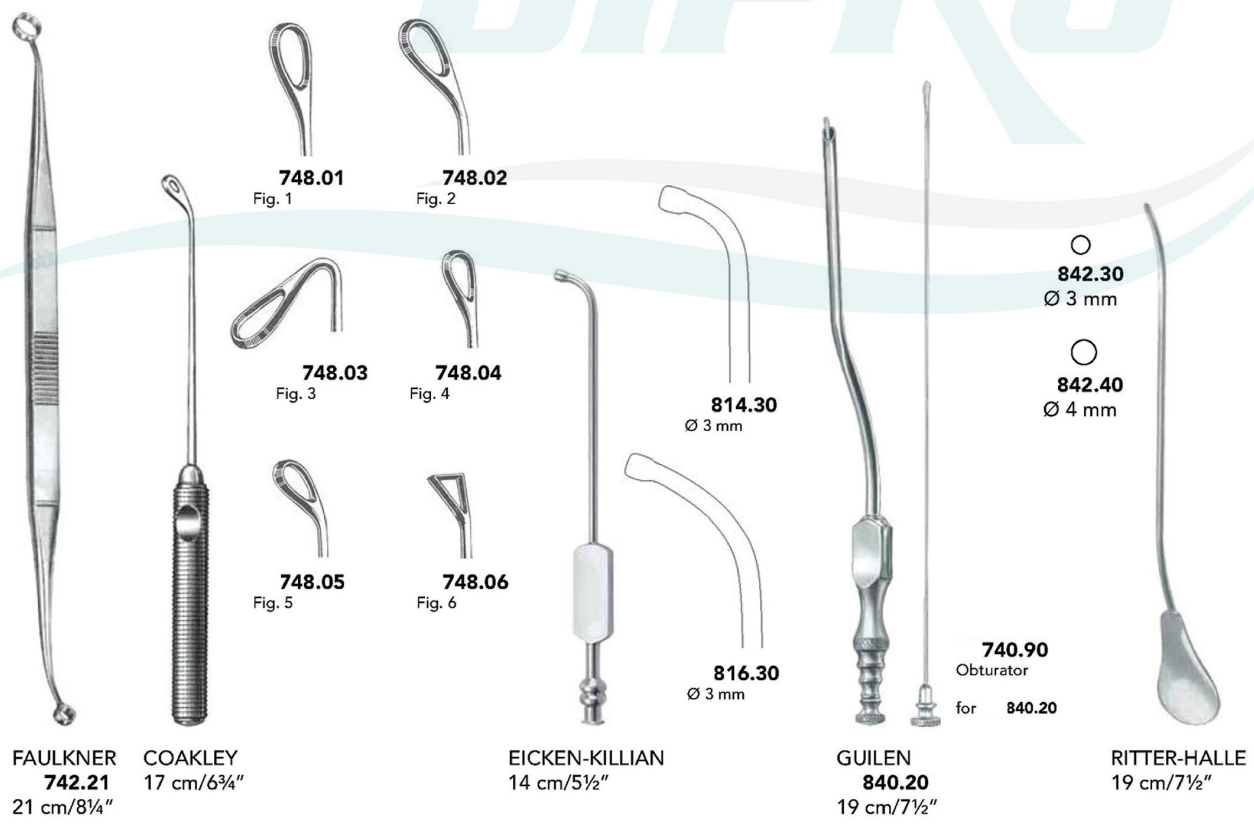

**FAULKNER 742.21** 21 cm/8¼"  
**COAKLEY 748.01** 17 cm/6¾"  
**748.02** Fig. 2  
**748.03** Fig. 3  
**748.04** Fig. 4  
**748.05** Fig. 5  
**748.06** Fig. 6  
**EICKEN-KILLIAN 814.30** 14 cm/5½"  
**Ø 3 mm**  
**816.30** Ø 3 mm  
**740.90** Obturator for **840.20**  
**842.30** Ø 3 mm  
**842.40** Ø 4 mm  
**GUILLEN 840.20** 19 cm/7½"  
**RITTER-HALLE 842.01** 19 cm/7½"

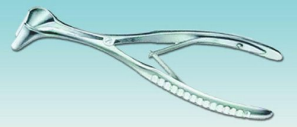

**Rhinology (Septum Straightening Forceps)**

Straight



**724.01**

Left



**724.02**

Right



**724.03**

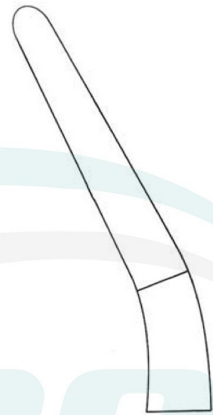

**KRESSNER**  
**721.20**  
22 cm/8¾"



**COTTLE-WALSHAM**  
23 cm/9"



**ASCH**  
**725.23**  
22.5 cm/9"



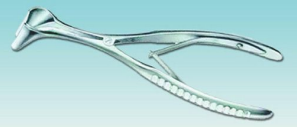

**Rhinology (Adenoid Curettes)**

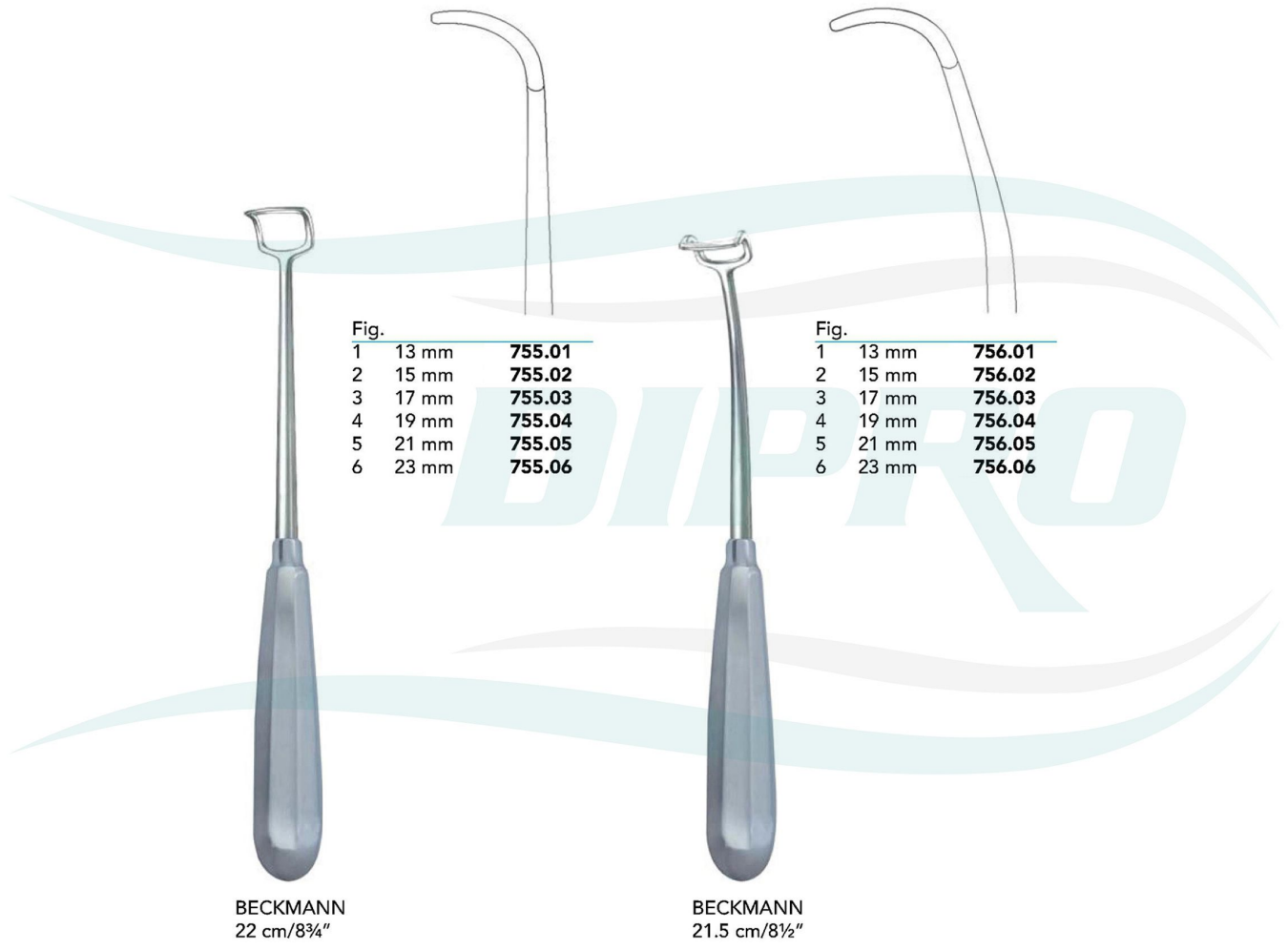

Fig.	Tip Size	Product Number
1	13 mm	755.01
2	15 mm	755.02
3	17 mm	755.03
4	19 mm	755.04
5	21 mm	755.05
6	23 mm	755.06

Fig.	Tip Size	Product Number
1	13 mm	756.01
2	15 mm	756.02
3	17 mm	756.03
4	19 mm	756.04
5	21 mm	756.05
6	23 mm	756.06

**BECKMANN**  
22 cm/8¾"

**BECKMANN**  
21.5 cm/8½"