



Neurosurgery (Skull Traction Tongs)



Wire saws

GIGLI	
30 cm/11"	600.30
40 cm/16"	600.40
50 cm/20"	600.50
60 cm/24"	600.60
70 cm/28"	600.70



Wire saw handle

GIGLI
602.01

Wire saw guide



DE MARTEL
618.33
33 cm/13"



Medium pattern

CRUTCHFIELD
641.02

Drill point
Ø 3.5 mm



NU641.04
7 cm/2¾"

Ø 5 mm



1641.05
7 cm/2¾"



GARDNER-WELLS
641.00

Maksimum açıklık (16 cm)
Maximum opening (16 cm)



641.01
Small pattern

CRUTCHFIELD



643.01
Large pattern

643.10

Spare pin for
32-7643-01



Neurosurgery (Carnial Rongeurs)

with 3 hooks



DAHLGREN
654.20
19.5 cm/7¾"

with 2 hooks



DE VII
658.21
21 cm/8¼"

Cranial Punch



CONE
659.22
22.5 cm/8¾"

Clip Applying Forceps



MCKENZIE
663.19
18.5 cm/7¼"



RANEY
676.00
15.5 cm/6"

Clip Applying Forceps



OLIVECRONA-TOENNIS
661.14



Neurosurgery (Dissectors)

Galea hook



YASARGIL
30 cm/11" **678.01**
41 cm/16¼" **678.02**



TOENNIS
680.25
24 cm/9½"



OLIVECRONA
681.24
24 cm/9½"



OLIVECRONA
682.18
18 cm/7"



OLIVECRONA
683.24
24 cm/9½"



OLIVECRONA
684.19
20 cm/8"



SACHS
685.21
20.5 cm/8¼"



MILLIGAN
686.21
22 cm/8¾"

Fig. 1



PENFIELD
690.01
17.5 cm/7"

Fig. 2



PENFIELD
690.02
19.5 cm/7¾"

Fig. 3



PENFIELD
690.03
19.5 cm/7¾"

Fig. 4



PENFIELD
690.04
20.5 cm/8"

Fig. 5



PENFIELD
690.05
18.5 cm/7¼"



688.22
22 cm/8¾"



Neurosurgery (Dissectors & Hooklets)

blunt

sharp

Fig. 1

Fig. 2

HOEN 530.39

HOEN 530.40

FRAZIER 530.38
Dissektor/Dissector
15 cm

ADSON 20 cm/8"

GRAHAM 825.16
16.5 cm/6½"

SACHS 827.18
17 cm/6¾"

823.20

824.20

1/2

DAVIS 687.21
21.5 cm/8½"

DAVIS 691.24
24.5 cm/9¾"

CUSHING Fig. 1 19 cm/7½"
742.19

CUSHING Fig. 2 28 cm/11"
742.28

744.19

744.28

Tumor fork

830.19

831.19

853.01
8 mm

853.02
5 mm

GRONINGEN 738.26
26.5 cm/10½"

GRONINGEN 740.26
26.5 cm/10½"

SMITHWICK 16.5 cm/6½"
748.17

SMITHWICK 21 cm/8¼"
748.21

19 cm/7½"

FRAZIER 13 cm/5"
835.13

FRAZIER 18 cm/7"
835.18

YASARGIL 20 cm/8"



Neurosurgery (Dissectors & Hooklets)

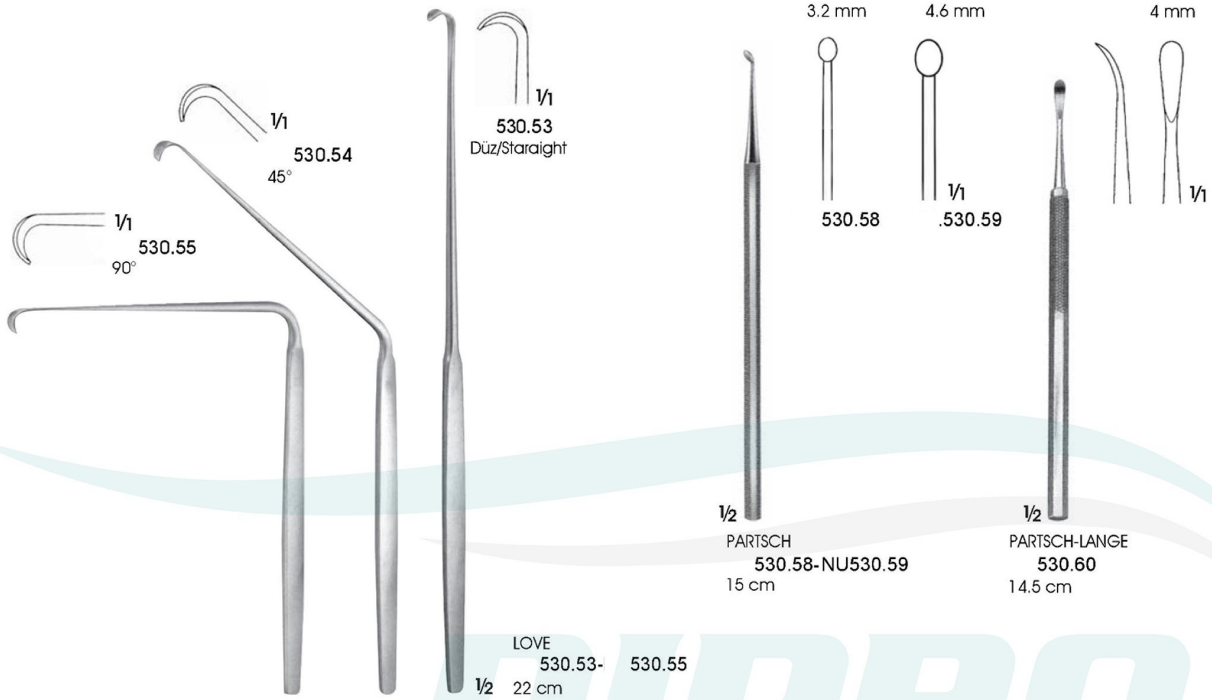

CASPAR
1000.31
Distraktör/Distractor
Sağ / Right
1000.33
Distraktör/Distractor
Sol / Left



CASPAR
1000.36 Ø 1.7 mm
Bükme matkapı/Twist drill
Delik derinliği/Drilling depth 8 mm
Sap çapı/Shank Ø 2.35
14.5 cm



1000.34
Matkap klavuzu
Sağ / Right
1000.35
Sol / Left

1000.37
Tornavida/Screw driver
20 cm

- CASPAR
- 1000.30 (Komple/Complete) Sağ (Right)
 - 1000.31 1 adet distraktör/1 each distractor
 - 1000.34 1 adet matkap klavuzu/1 each drill guide
 - 1000.36 1 adet matkap/1 each twist drill
 - 1000.39 2 adet distraksiyon vidası/2 each distraction screws
 - 1000.37 1 adet tornavida/1 each Screw driver

- CASPAR
- 1000.32 (Komple/Complete) Sol (Left)
 - 1000.33 1 adet distraktör/1 each distractor
 - 1000.35 1 adet matkap klavuzu/1 each drill guide
 - 1000.36 1 adet matkap/1 each twist drill
 - 1000.39 2 adet distraksiyon vidası/2 each distraction screws
 - 1000.37 1 adet tornavida/1 each Screw driver



Neurosurgery (Micro & Neuro Instruments)

Tissue claw



853.03
18.5 cm/7"

Suture guide



YASARGIL
18.5 cm/7 1/4"

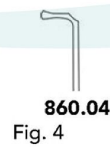
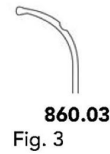
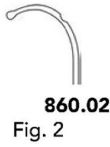
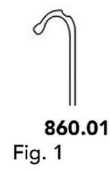

Micro raspatory



YASARGIL

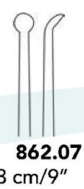
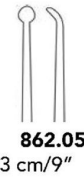
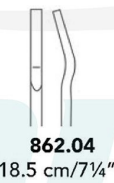
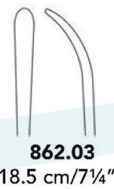
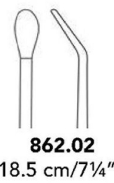
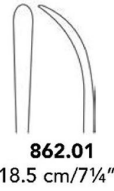

Tumor knife



SAMII
23 cm/9"

1.0 mm	854.01	
1.5 mm	854.02	854.09
2.0 mm	854.03	
2.5 mm	854.04	
3.0 mm	854.05	854.10
3.5 mm	854.06	
4.0 mm	854.07	
4.5 mm		854.11
5.0 mm	854.08	
6.0 mm		854.12

Micro raspatory bayonet



YASARGIL
18.5 cm/7 1/4"

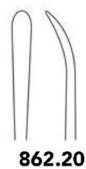

Micro dissector straight



YASARGIL

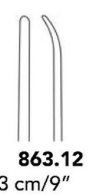
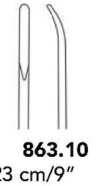
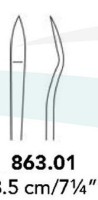

Micro dissector bayonet



YASARGIL
23 cm/9"



Buttoned probe



JACOBSON
864.02
18.5 cm/7 1/4"

Probe double



JACOBSON
864.01
18.5 cm/7 1/4"

Micro curette



YASARGIL
865.01
18.5 cm/7 1/4"



Neurosurgery (Micro & Neuro Instruments)

Micro curette



865.10
865.11

YASARGIL
23 cm/9"

Dura hook



sharp
866.01
blunt
866.02

YASARGIL
23 cm/9"

Micro hooklet



KRAYENBUEHL
19 cm/7½"



940.01
Fig. 1
940.03
Fig. 3



940.02
Fig. 2
940.04
Fig. 4

Micro dissector



4.5 mm
856.01
23 cm/9"
1.0 mm
856.04
20 cm/8"

CASPER

1 mm



858.01
23 cm/9"



JACOBSON
858.30

SAMII

Bayonet



KOOS
858.10
18.5 cm/7¼"
858.12
18.5 cm/7¼"

YASARGIL
858.20
18.5 cm/7¼"

KOOS
858.11
18.5 cm/7¼"
858.13
18.5 cm/7¼"

YASARGIL
858.21
18.5 cm/7¼"

Micro vascular knife

90°

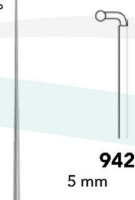

942.05
5 mm



942.09
9 mm

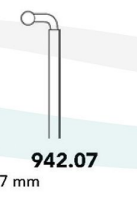

942.07
7 mm

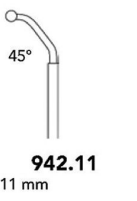

942.11
11 mm

CASPER
24.5 cm/9¾"

bayonet



CASPER

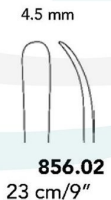

856.02
23 cm/9"



856.05
20 cm/8"



856.10
23 cm/9"



856.03
23 cm/9"



856.06
20 cm/8"



Neurosurgery (Lamina Spreaders)



INGE
977.27
25.5 cm/10"



CLOWARD
NU973.15



CLOWARD
NU973.16
16 cm/6¼"



INGE
975.17
16 cm/6¼"



CLOWARD
974.17
16 cm/6¼"



Neurosurgery (Rongeurs)

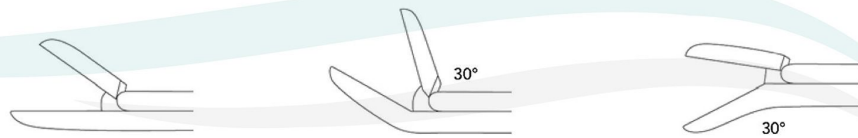
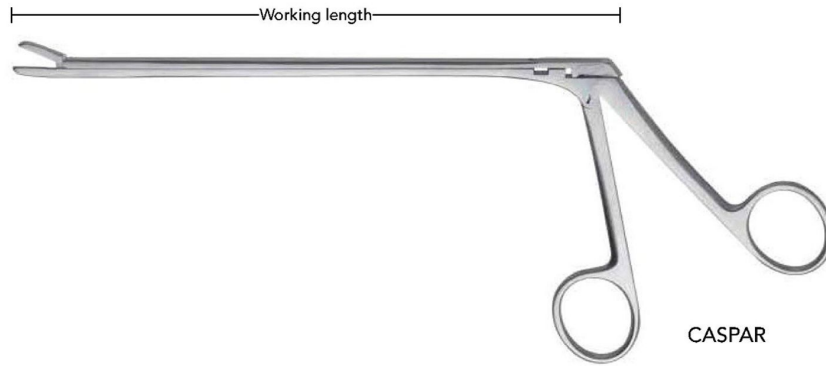

2 mm	Working length						
	15 cm/6"	981.05	982.05	981.25	982.25	981.45	982.45
	18 cm/7"	981.09	982.09	981.29	982.29	981.49	982.49
	20 cm/8"	981.13	982.13	981.33	982.33	981.53	982.53
	30 cm/11¾"	981.17	982.17	981.37	982.37	981.57	982.57

3 mm	Working length						
	15 cm/6"	981.06	982.06	981.26	982.26	981.46	982.46
	18 cm/7"	981.10	982.10	981.30	982.30	981.50	982.50
	20 cm/8"	981.14	982.14	981.34	982.34	981.54	982.54
	30 cm/11¾"	981.18	982.18	981.38	982.38	981.58	982.58

4 mm	Working length						
	15 cm/6"	981.07	982.07	981.27	982.27	981.47	982.47
	18 cm/7"	981.11	982.11	981.31	982.31	981.51	982.51
	20 cm/8"	981.15	982.15	981.35	982.35	981.55	982.55
	30 cm/11¾"	981.19	982.19	981.39	982.39	981.59	982.59

5 mm	Working length						
	15 cm/6"	981.08	982.08	981.28	982.28	981.48	982.48
	18 cm/7"	981.12	982.12	981.32	982.32	981.52	982.52
	20 cm/8"	981.16	982.16	981.36	982.36	981.56	982.56
	30 cm/11¾"	981.20	982.20	981.40	982.40	981.60	982.60

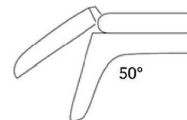
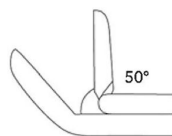

4 mm	Working length		
	18 cm/7"	980.80	984.80
	30 cm/11¾"	981.81	985.81

Working length			
	18 cm/7"	982.80	986.80
	30 cm/11¾"	983.81	987.81



Neurosurgery (Rongeurs)

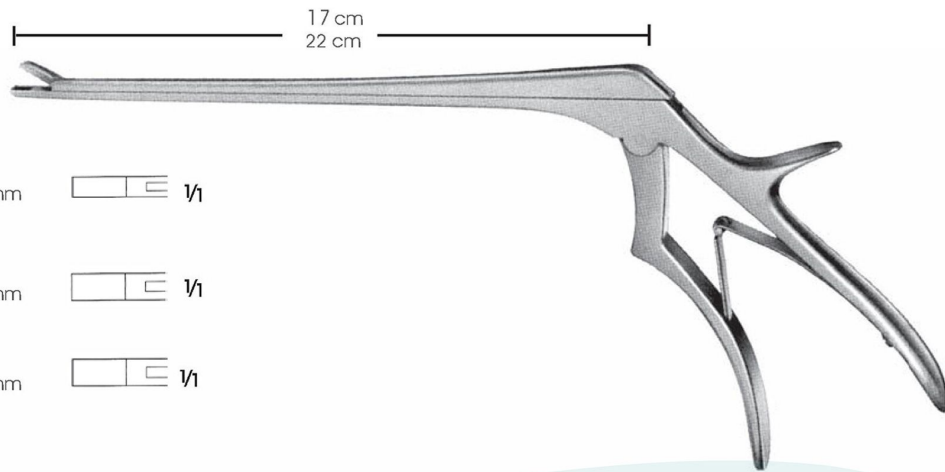

CASPAR
500.34 3 mm
18 cm

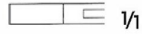

CASPAR
500.35 4 mm
18 cm



CASPAR
500.36 4 mm
20.5 cm

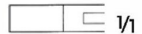

14 cm

HOEN
500.37

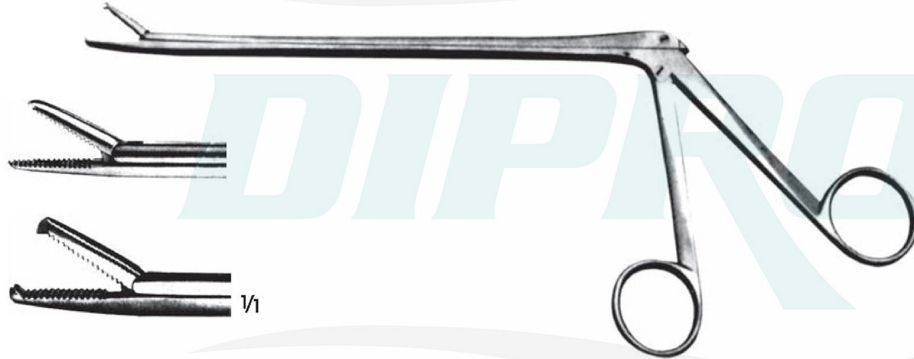

500.38

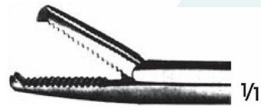

15 cm

1 x 2 dis
1 x 2 teeth



KRAMER

500.39 15 cm

Bağ tutucu grasping pens, kilitti
With catch grasping forceps for
ligamentum flavum



Neurosurgery (Rongeurs)

Mil uzunluđu Length of shaft 14 cm	Mil uzunluđu Length of shaft 16 cm	Mil uzunluđu Length of shaft 18.5 cm	Çene ölçüleri Size of jaws		
500.04	500.09	500.14	2 x 12 mm		1/1
500.05	500.10	500.15	3 x 12 mm		1/1
500.06	500.11	500.16	4 x 14 mm		1/1
500.07	500.12	500.17	5 x 14 mm		1/1
500.08	500.13	500.18	6 x 16 mm		1/1

Mil uzunluđu
Length of shaft

CASPAR
500.04- 500.18

1/2

Mil uzunluđu Length of shaft 14 cm	Mil uzunluđu Length of shaft 16 cm	Mil uzunluđu Length of shaft 18.5 cm	Çene Ölçüleri Size of jaws		
500.19	500.22	500.25	3 x 12 mm		1/1
500.20	500.23	500.26	4 x 14 mm		1/1
500.21	500.24	500.27	5 x 14 mm		1/1

Mil uzunluđu
Length of shaft

150°

CASPAR
500.19- 500.27

1/2

Mil uzunluđu Length of shaft 14 cm	Mil uzunluđu Length of shaft 16 cm	Mil uzunluđu Length of shaft 18.5 cm	Çene Ölçüleri Size of jaws		
500.28	500.30	500.32	3 x 12 mm		1/1
500.29	500.31	500.33	4 x 14 mm		1/1

Mil uzunluđu
Length of shaft

Alt çene hareketli
Lower part of jaw movable

150°

CASPAR
500.28- 500.33

1/2



Neurosurgery (Rongeurs)

LOVE-GRUENWALD

500.01 2 x 10 mm



500.02 3 x 10 mm



SPURLING

500.03 4 x 10 mm



CUSHING

530.34 4 mm



1/1

530.35 5 mm

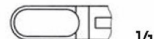

1/1

530.36 6 mm



1/1

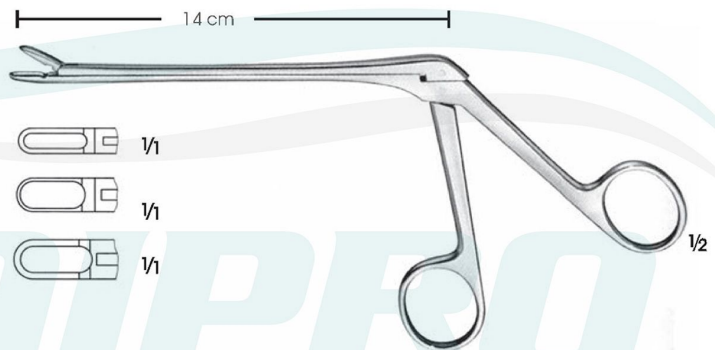

CUSHING

530.41 3 mm



1/1

530.42 4 mm



1/1

530.43 5 mm

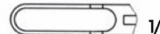

1/1



CUSHING

530.44 3 mm



530.45 4 mm



1/1

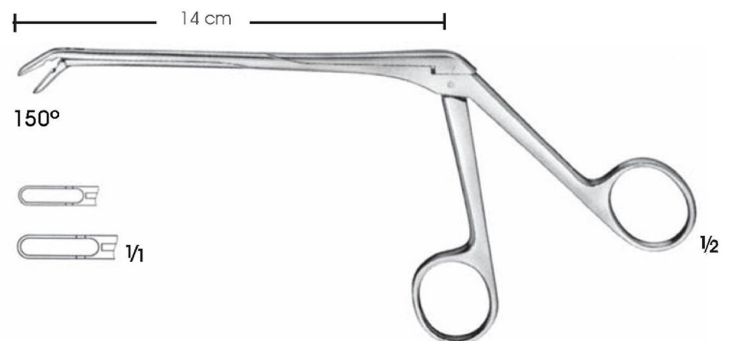



Neurosurgery (Rongeurs)

CUSHING
530.46 2 x 10 mm

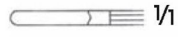

LOVE-GRUENWALD
530.47 3 x 10 mm

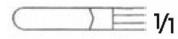

SPURLING
530.48 4 x 10 mm

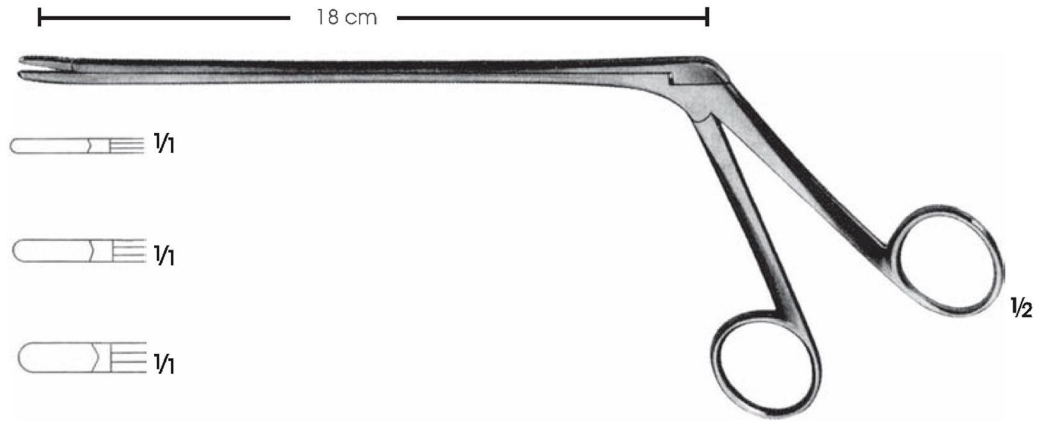
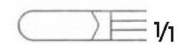

LOVE-GRUENWALD
530.49 3 x 10 mm

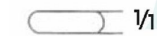

SPURLING
530.50 4 x 10 mm



Üst çene hareketli
Upper part of jaw movable

LOVE-GRUENWALD
530.51 3 x 10 mm



SPURLING
530.52 4 x 10 mm

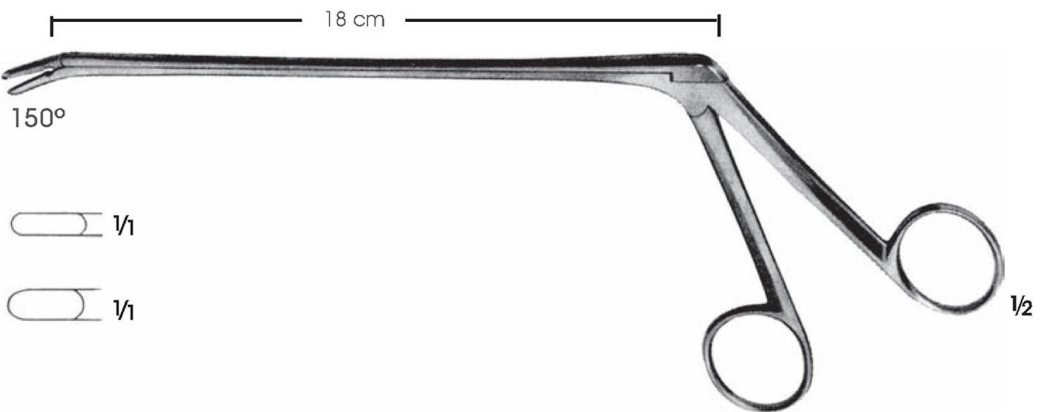



Neurosurgery (Laminectomy Punches)

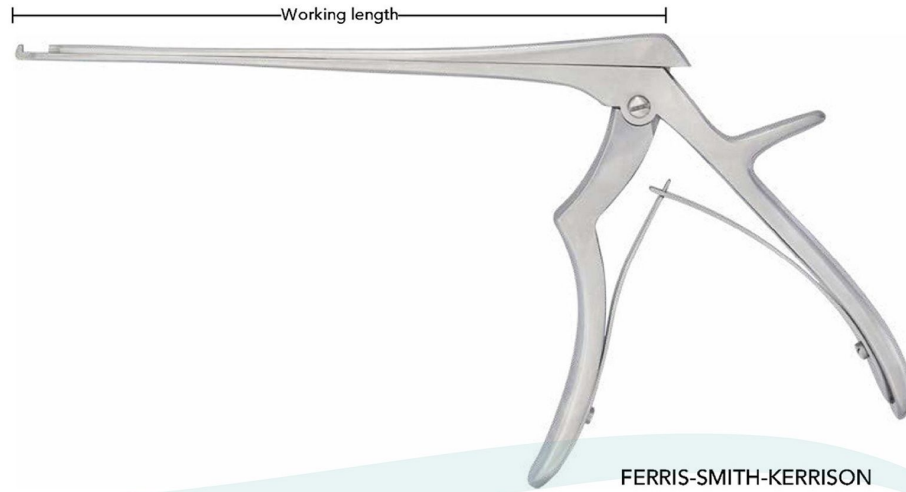

	Working length	Cutting upwards 40°			Cutting upwards 90°		
		Standard 40°	Detachable / TC 40°	Black Coated 40°	Standard 90°	Detachable / TC 90°	Black Coated 90°
1 mm	18 cm/7"	978.01	978.01DT	478.01	978.02	978.02DT	478.02
	20 cm/7¾"	978.03	978.03DT	478.03	978.04	978.04DT	478.04
	23 cm/9"	978.05	978.05DT	478.05	978.06	978.06DT	478.06
	28 cm/11"	978.07	978.07DT	478.07	978.08	978.08DT	478.08
2 mm	18 cm/7"	978.09	978.09DT	478.09	978.10	978.10DT	478.10
	20 cm/7¾"	978.11	978.11DT	478.11	978.12	978.12DT	478.12
	23 cm/9"	978.13	978.13DT	478.13	978.14	978.14DT	478.14
	28 cm/11"	978.15	978.15DT	478.15	978.16	978.16DT	478.16
3 mm	18 cm/7"	978.17	978.17DT	478.17	978.18	978.18DT	478.18
	20 cm/7¾"	978.19	978.19DT	478.19	978.20	978.20DT	478.20
	23 cm/9"	978.21	978.21DT	478.21	978.22	978.22DT	478.22
	28 cm/11"	978.23	978.23DT	478.23	978.24	978.24DT	478.24
4 mm	18 cm/7"	978.25	978.25DT	478.25	978.26	978.26DT	978.26
	20 cm/7¾"	978.27	978.27DT	478.27	978.28	978.28DT	978.28
	23 cm/9"	978.29	978.29DT	478.29	978.30	978.30DT	978.30
	28 cm/11"	978.31	978.31DT	478.31	978.32	978.32DT	978.32
5 mm	18 cm/7"	978.33	978.33DT	478.33	978.34	978.34DT	478.34
	20 cm/7¾"	978.35	978.35DT	478.35	978.36	978.36DT	478.36
	23 cm/9"	978.37	978.37DT	478.37	978.38	978.38DT	478.38
	28 cm/11"	978.39	978.39DT	478.39	978.40	978.40DT	478.40
6 mm	18 cm/7"	978.41	978.41DT	478.41	978.42	978.42DT	478.42
	20 cm/7¾"	978.43	978.43DT	478.43	978.44	978.44DT	478.44
	23 cm/9"	978.45	978.45DT	478.45	978.46	978.46DT	478.46
	28 cm/11"	978.47	978.47DT	478.47	978.48	978.48DT	478.48



Neurosurgery (Laminectomy Punches)

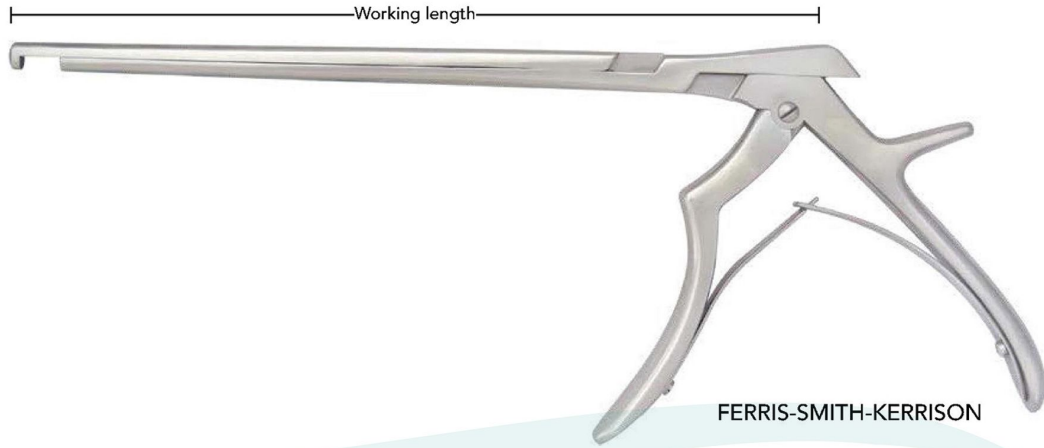

Working length	Cutting downwards 40°		Cutting downwards 90°		
	40°	40°	90°	90°	
1 mm	18 cm/7"	.978.50	478.50	.978.51	478.51
	20 cm/7¾"	.978.52	478.52	.978.53	478.53
	23 cm/9"	.978.54	478.54	.978.55	478.55
2 mm	18 cm/7"	978.56	478.56	978.57	478.57
	20 cm/7¾"	978.58	478.58	978.59	478.59
	23 cm/9"	978.60	478.60	978.61	478.61
3 mm	18 cm/7"	978.62	478.62	978.63	478.63
	20 cm/7¾"	978.64	478.64	978.65	478.65
	23 cm/9"	978.66	478.66	978.67	478.67
4 mm	18 cm/7"	978.68	478.68	978.69	478.69
	20 cm/7¾"	978.70	478.70	978.71	478.71
	23 cm/9"	978.72	478.72	978.73	478.73
5 mm	18 cm/7"	978.74	478.64	978.75	478.75
	20 cm/7¾"	978.76	478.76	978.77	478.77
	23 cm/9"	978.78	478.78	978.79	478.79
6 mm	18 cm/7"	978.80	478.80	978.81	478.81
	20 cm/7¾"	978.82	478.82	978.83	478.83
	23 cm/9"	978.84	478.84	978.85	478.85



Neurosurgery (Rongeurs)

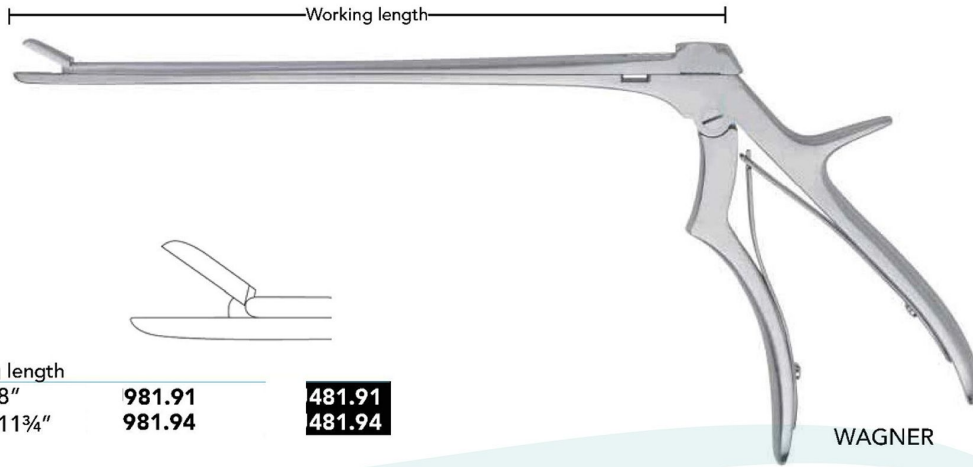

3 mm	Working length		
	20 cm/8"	981.91	481.91
	30 cm/11¾"	981.94	481.94

WAGNER

4 mm	Working length		
	20 cm/8"	981.92	481.92
	30 cm/11¾"	981.95	481.95



5 mm	Working length					
	15 cm/6"	981.93	481.93	981.84	481.84	981.86
	18 cm/7"	981.96	481.96	981.85	481.85	981.87

185 mm



LANDOLT
996.27
27 cm/10¾"

Shaft length

996.50	996.51
180 mm	200 mm

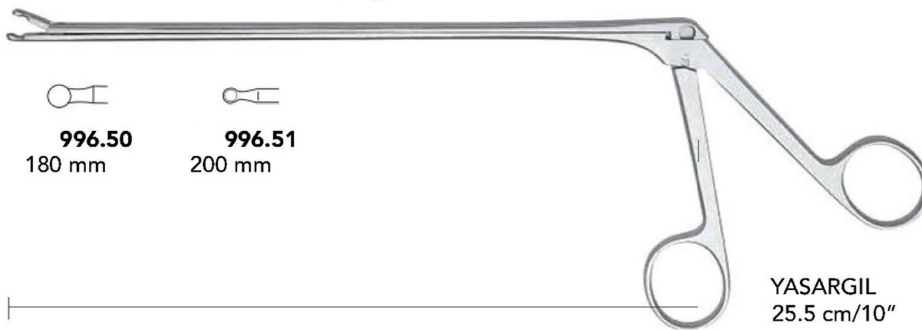

YASARGIL
25.5 cm/10"



Neurosurgery (Micro Forceps)

Jaw spoon-shaped

Ø 3 mm Ø 4 mm Ø 5 mm

Ø 3 mm Ø 4 mm Ø 5 mm

YASARGIL-SAMII

23 cm/9"	852.01	852.02	852.03	853.01	853.02	853.03
----------	---------------	---------------	---------------	---------------	---------------	---------------

Jaw spoon-shaped Jaw flat, serrated Curette jaw, toothed

Ø 3 mm Ø 5 mm Ø 7 mm Ø 3 mm Ø 5 mm Ø 3 mm Ø 5 mm

YASARGIL YASARGIL

22 cm/8¾"	863.22	865.22	867.22	20 cm/8"	871.20	872.20	873.22	875.22
24 cm/9½"	863.24	865.24	867.24	22 cm/8¾"	871.22	872.22		

Ø 0.6 mm Ø 0.9 mm 1:2

Jaw flat, serrated Ø 5 mm Ø 5 mm

YASARGIL HUNT

16 cm/6¼"	856.16	859.16		890.20	891.20
18 cm/7"	856.18	859.18	860.18		
20 cm/8"	856.20	859.20			
22 cm/8¾"	856.22	859.22			
24 cm/9½"	856.24	859.24			

20 cm/8"



Neurosurgery (Micro Scissors)

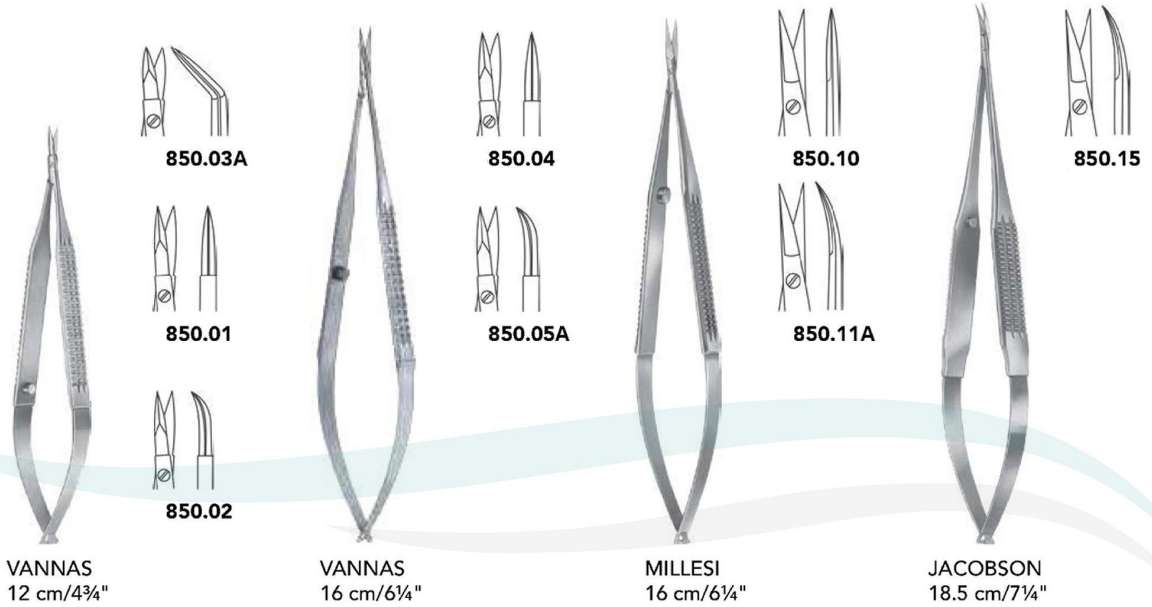

DIPRO



YASARGIL

Adventitia Blades

	Curved upwards	Curved downwards
16 cm/6¼"	850.16B	851.16
20 cm/8"	850.20	851.20
22.5 cm/9"	850.22B	851.22
24.5 cm/9¾"		853.20A
		851.24

Dissection Blades

	Curved upwards
20 cm/8"	854.20
22.5 cm/9"	854.22A
	855.20
	855.22



Neurosurgery (Micro Scissors Ring Type, Micro Needle Holders, Perforators)

Micro Needle Holders

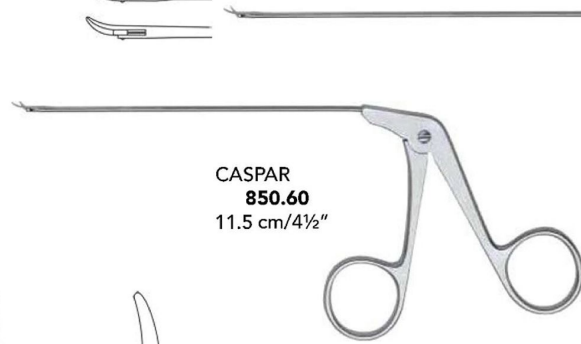
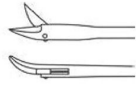

CASPAR
850.60
11.5 cm/4½"

FAHLBUSCH
850.50
16.5 cm/6½"

Micro Needle Holders

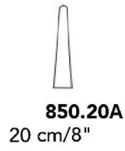

850.20A
20 cm/8"

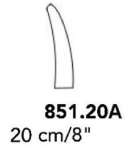

851.20A
20 cm/8"

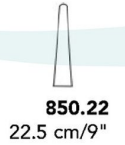

850.22
22.5 cm/9"

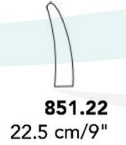

851.22
22.5 cm/9"



YASARGIL



852.18A
without catch

JACOBSON
18 cm/7"



854.18
with catch

JACOBSON
18 cm/7"



546.02
Sadece matkap kolu
Brace only

HUDSON
546.00
Komple/Complete
V 502.01, V 502.02, V 500.03,
V 500.04, V 500.05, V 500.06,
V 500.07



HUDSON
546.01
Sadece uzatma parçası
Extension piece only



CUSHING
546.03
Ø 10 mm



CUSHING
546.04
Ø 15 mm



CUSHING
546.05
Ø 14 mm



McKENZIE
546.06
Ø 13 mm



HUDSON
546.07
Ø 14 mm



HUDSON
546.08
Ø 16 mm



ADSON
546.09
Ø 15 mm



HUDSON
546.10
Ø 22 mm



HUDSON
546.11
Ø 9 mm



OP546.12
Ø 2 mm