

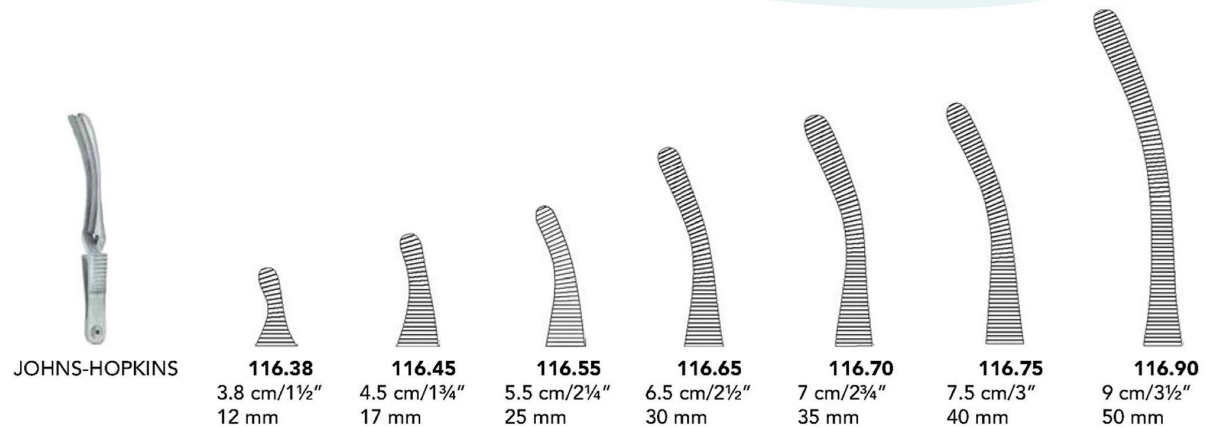

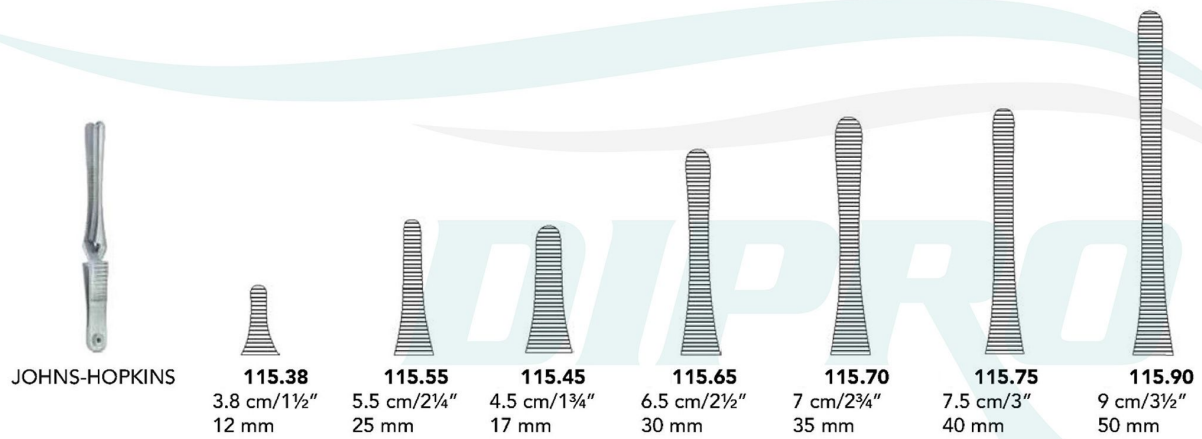

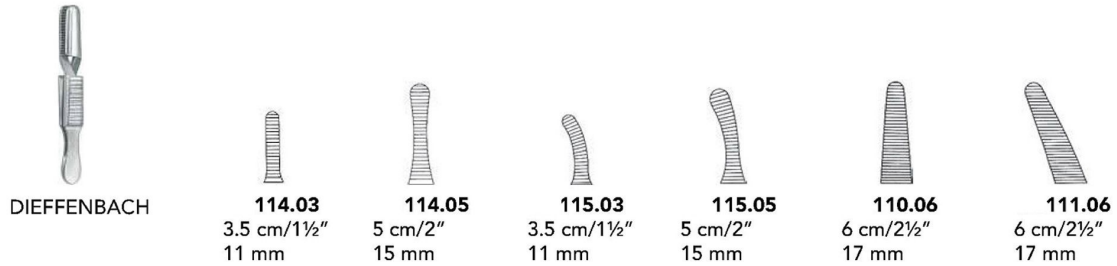

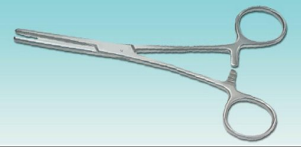



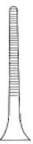
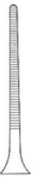

Haemostatic Forceps (Bulldog Clamps)



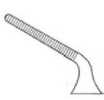
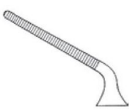





Haemostatic Forceps (Bulldog Clamps)

							
	120.08 4.5 cm/1¾" 8 mm	120.10 5 cm/2" 12 mm	120.12 6 cm/2¼" 20 mm	DEBAKEY	122.10 4.5 cm/1¾"	122.14 5 cm/2"	122.20 6 cm/2¼"
							
DIETHRICH	121.08 4 cm/1½" 8 mm	121.10 4.5 cm/1¾" 12 mm	121.12 5 cm/2" 20 mm	DIETHRICH	123.10 4.5 cm/1¾"	123.14 5 cm/2"	123.20 6 cm/2¼"

Mini-GLOVER





ATRAUMA
DEBAKEY



				
	3 cm/1¼"	3.5 cm/1½"	4.0 cm/1½"	5.0 cm/2"
Vena	132.30	132.35	132.40	132.50
Artria	142.30	142.35	142.40	142.50





Mini-GLOVER



				
	3 cm/1¼"	3.5 cm/1½"	4.0 cm/1½"	5.0 cm/2"
Vena	133.30	133.35	133.40	133.50
Artria	143.30	143.35	143.40	143.50

Mini-GLOVER



				
	3 cm/1¼"	3.5 cm/1½"	4.0 cm/1½"	5.0 cm/2"
Vena	135.30	135.35	135.40	135.50
Artria	145.30	145.35	145.40	145.50

Applying forceps



Mini-GLOVER
131.24
24 cm/9½"

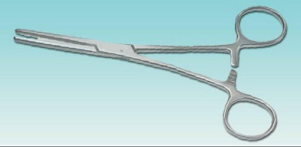

Haemostatic Forceps (Organ Grasping Forceps)

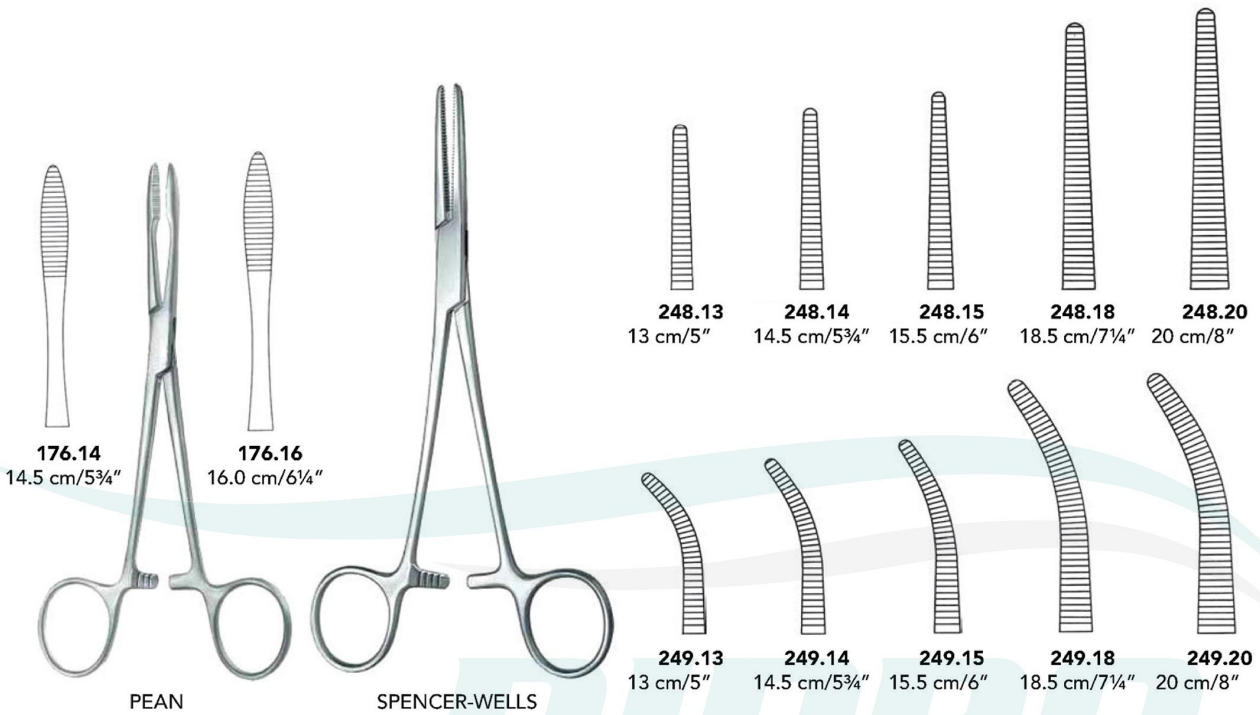

Organ grasping forceps

ATRAUMA

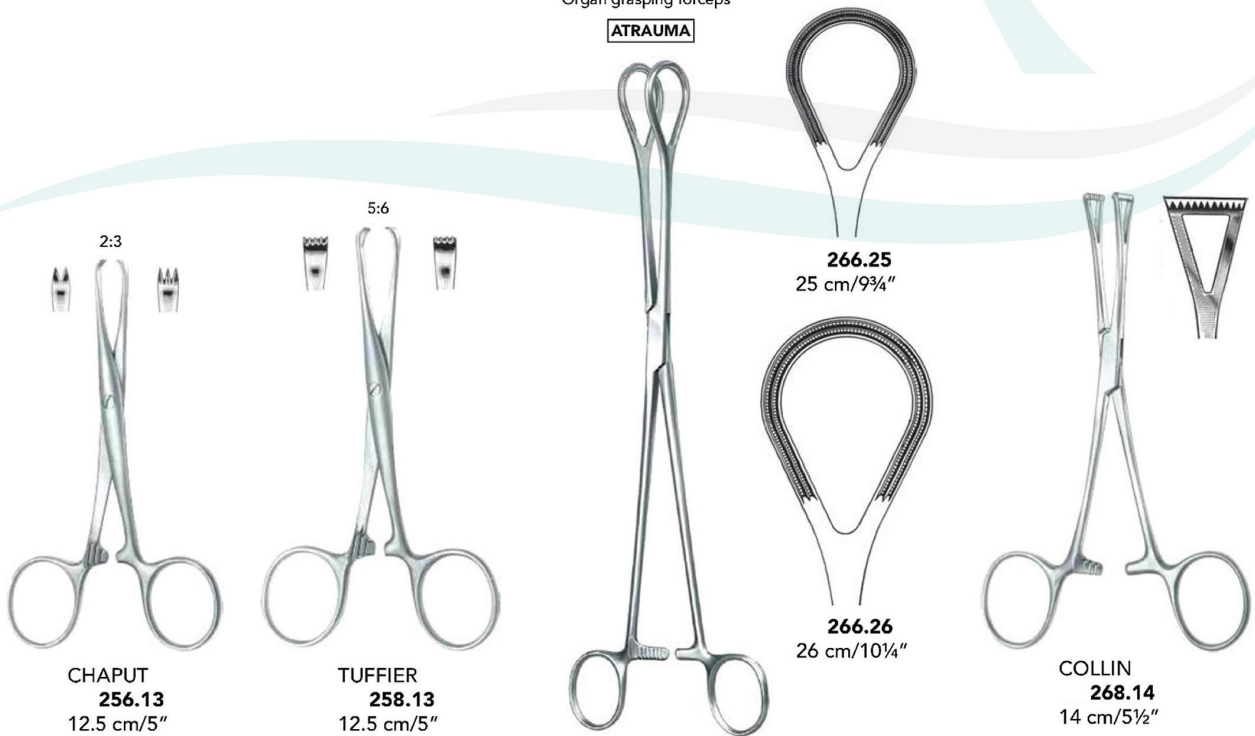

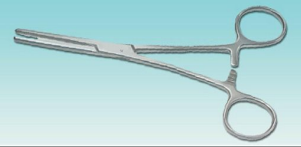

Haemostatic Forceps (Organ Grasping, Dissecting, Ligature Forceps)

Tumor grasping forceps

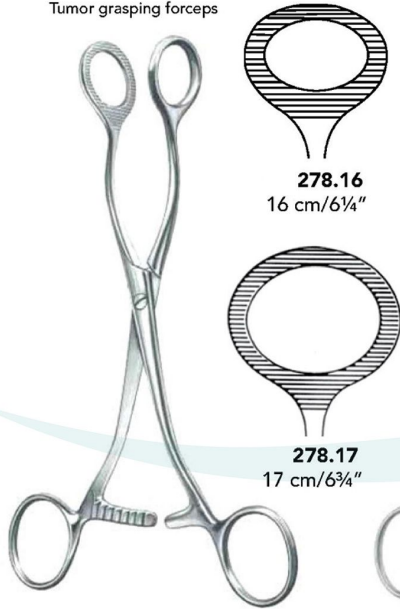

COLLIN



Organ grasping forceps



PENNINGTON
15.5 cm/6" **280.15**
21.0 cm/8¼" **280.20**



PRATT
282.15
15 cm/6"

Face-lift forceps



MARTEL-REES
290.14
13.5 cm/5¼"

Ligature forceps
smooth jaw



MARTEL
302.12
12.5 cm/5"

Ligature forceps

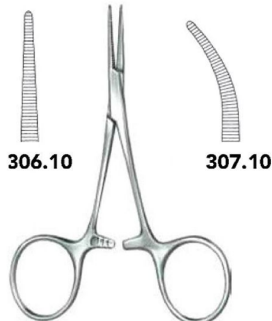

HARTMANN
10 cm/4"

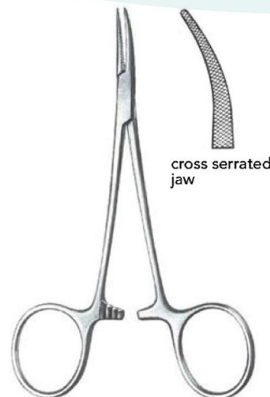

309.12
12 cm/4¾"

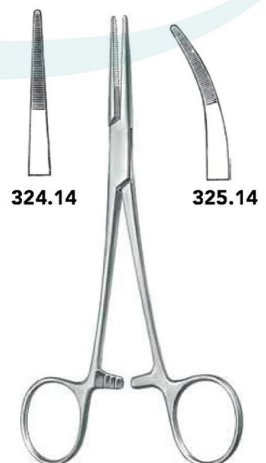

324.14 **325.14**
PROVIDENCE-HOSPITAL
14 cm/5½"

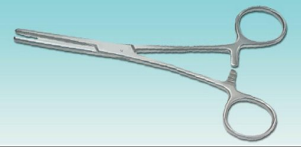

Haemostatic Forceps (Dissecting & Ligature Forceps)



HALSTED-MOSQUITO



310.12
12.5 cm/5"



311.12
12.5 cm/5"



310.14
14.5 cm/5¾"



311.14
14.5 cm/5¾"

1:2



312.12
12.5 cm/5"



313.12
12.5 cm/5"



312.14
14.5 cm/5¾"



313.14
14.5 cm/5¾"

DIPRO



HALSTED-MOSQUITO



316.18
18.5 cm/7¼"



317.18
18.5 cm/7¼"



316.21
21 cm/8¼"



317.21
21 cm/8¼"

1:2



318.18
18.5 cm/7¼"



319.18
18.5 cm/7¼"



318.21
21.0 cm/8¼"



319.21
21.0 cm/8¼"

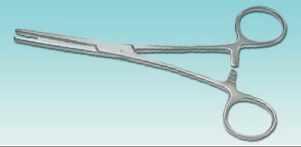

Haemostatic Forceps (Dissecting & Ligature Forceps)

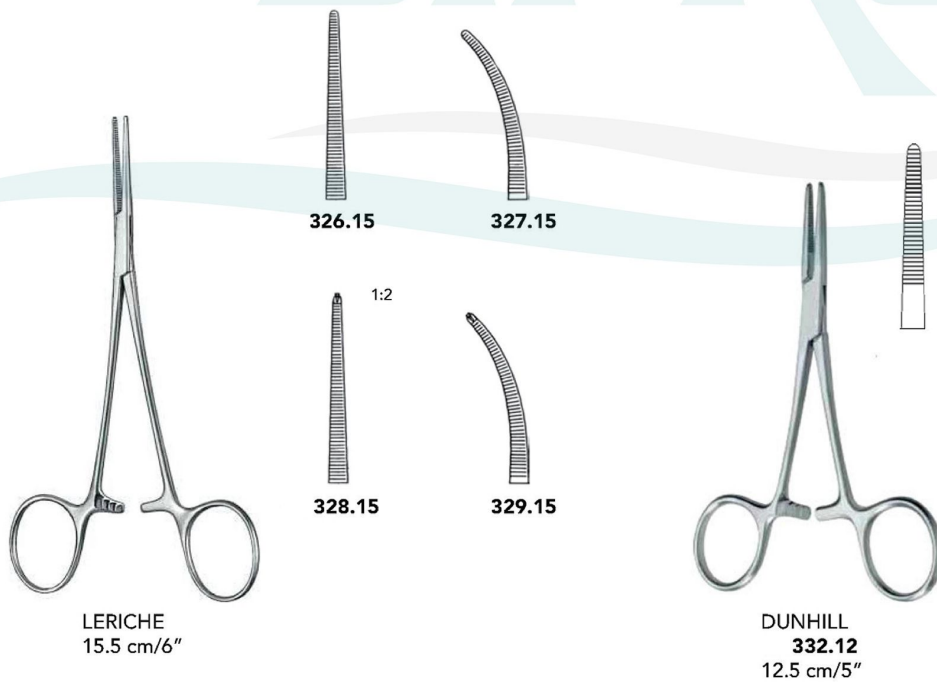
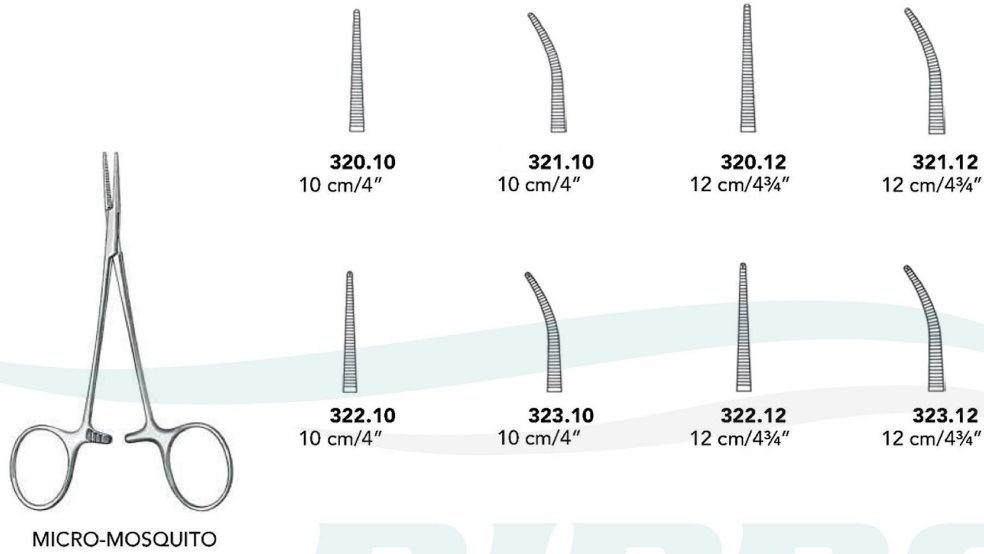

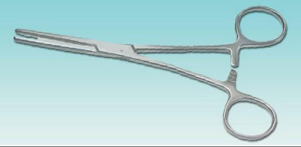

Haemostatic Forceps (Dissecting & Ligature Forceps)



DUNHILL
333.19
18.5 cm/7¼"



330.14

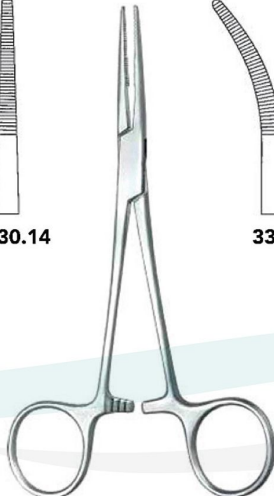

KELLY
14.5 cm/5¾"



331.14



334.16

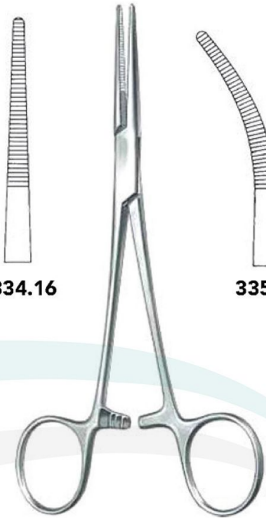

KELLY-RANKIN
16 cm/6¼"



335.16



340.14



341.14



346.16

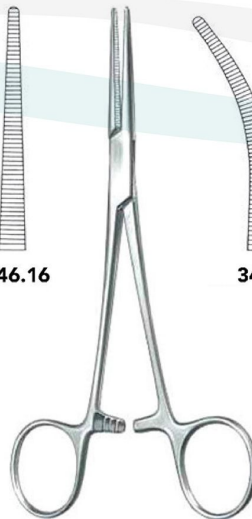

CRILE-RANKIN
16 cm/6¼"



347.16



348.15

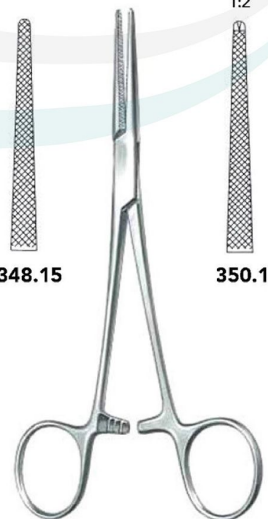

LOVELACE
16 cm/6¼"



350.15

1:2



342.14



343.14

Cross serrated jaw

1:2



CRILE
14.5 cm/5¾"

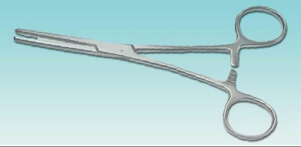

Haemostatic Forceps (Dissecting & Ligature Forceps)

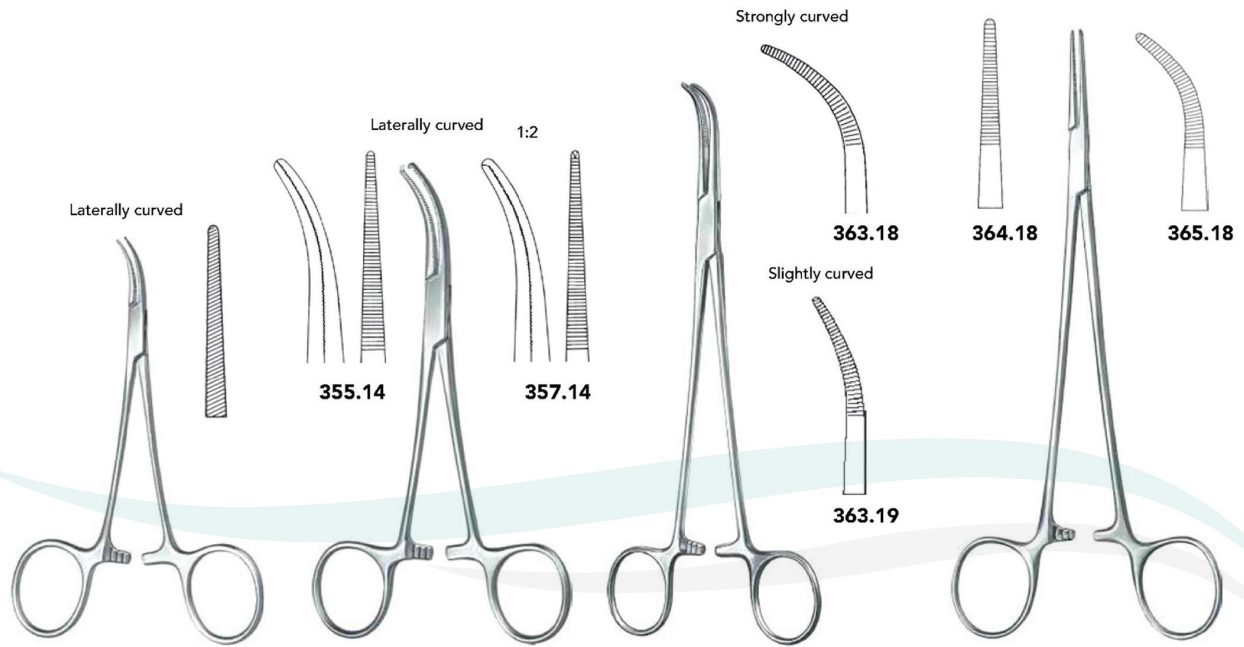

DANDY-MOSQUITO
351.12
12 cm/4¾"

DANDY
14.5 cm/5¾"

SCHNIDT
18.5 cm/7¼"

ADSON
18.5 cm/7¼"



FUCHSIG
369.20
18.5 cm/7¼"

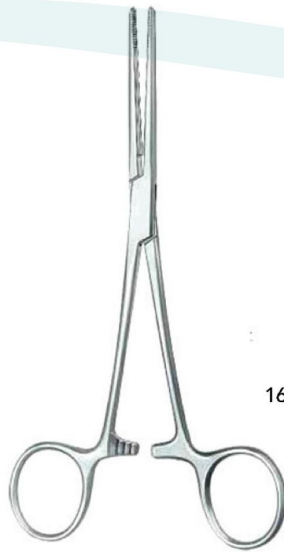

ROCHESTER-CARMALT

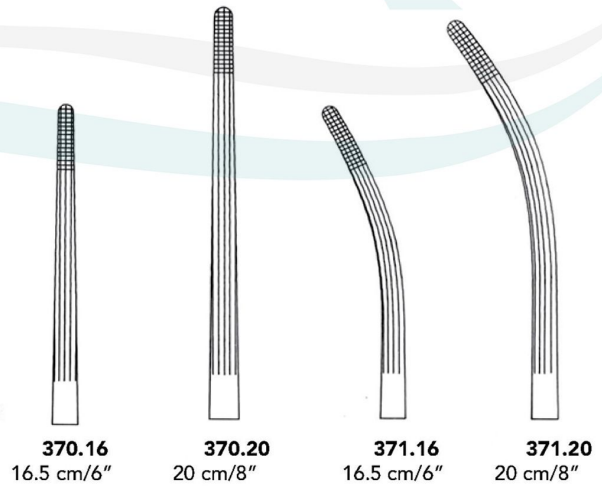

370.16
16.5 cm/6"

370.20
20 cm/8"

371.16
16.5 cm/6"

371.20
20 cm/8"

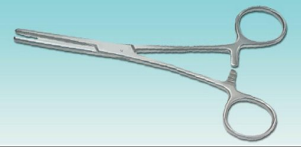

Haemostatic Forceps

Straight

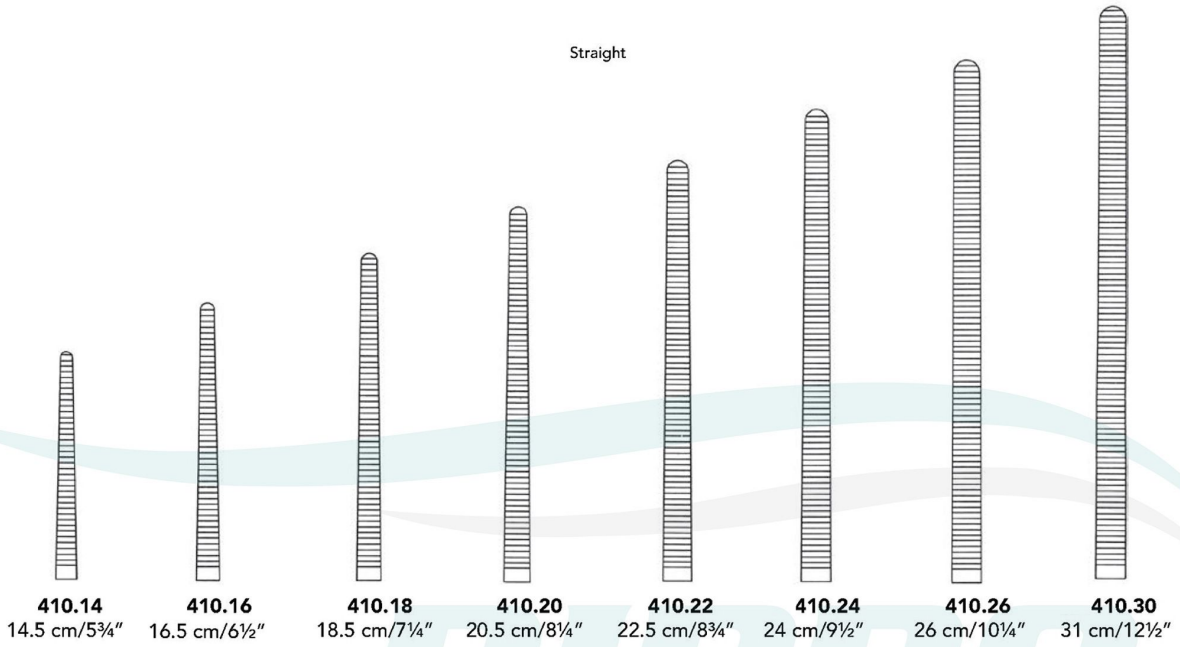

Curved

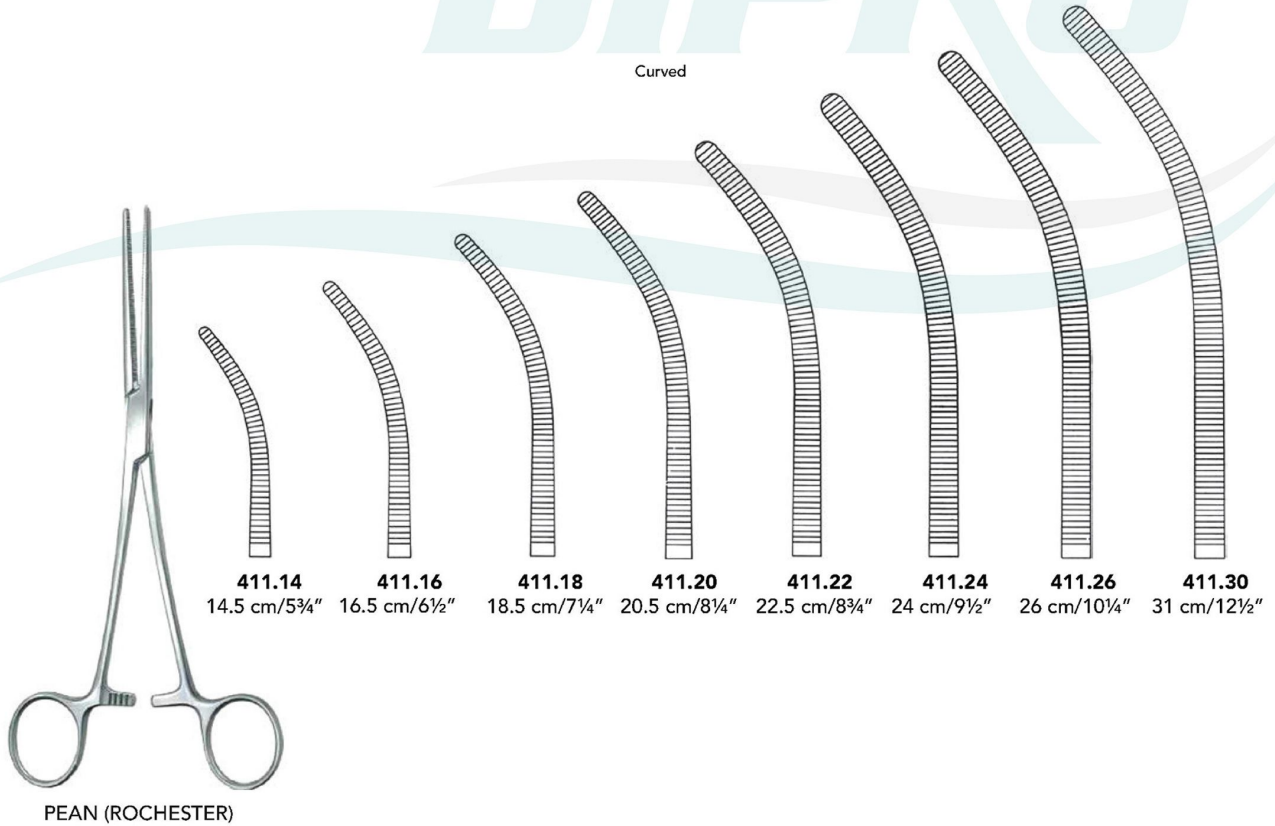

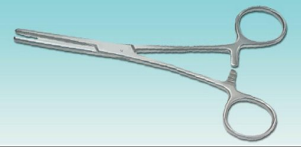

Haemostatic Forceps

Straight

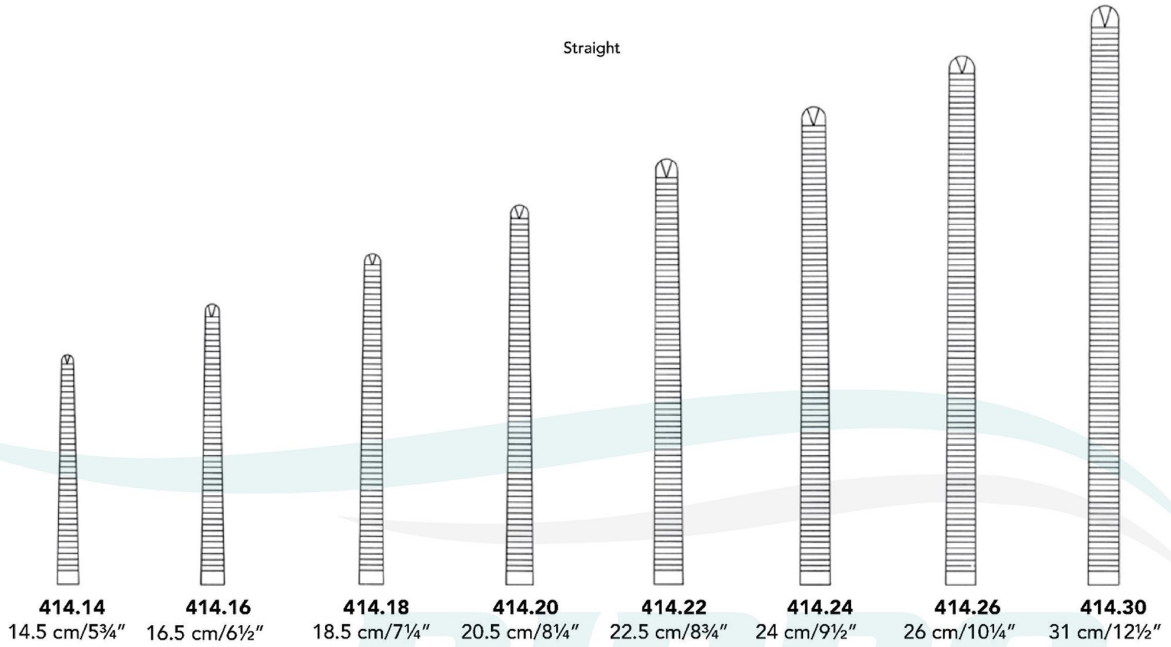

Curved

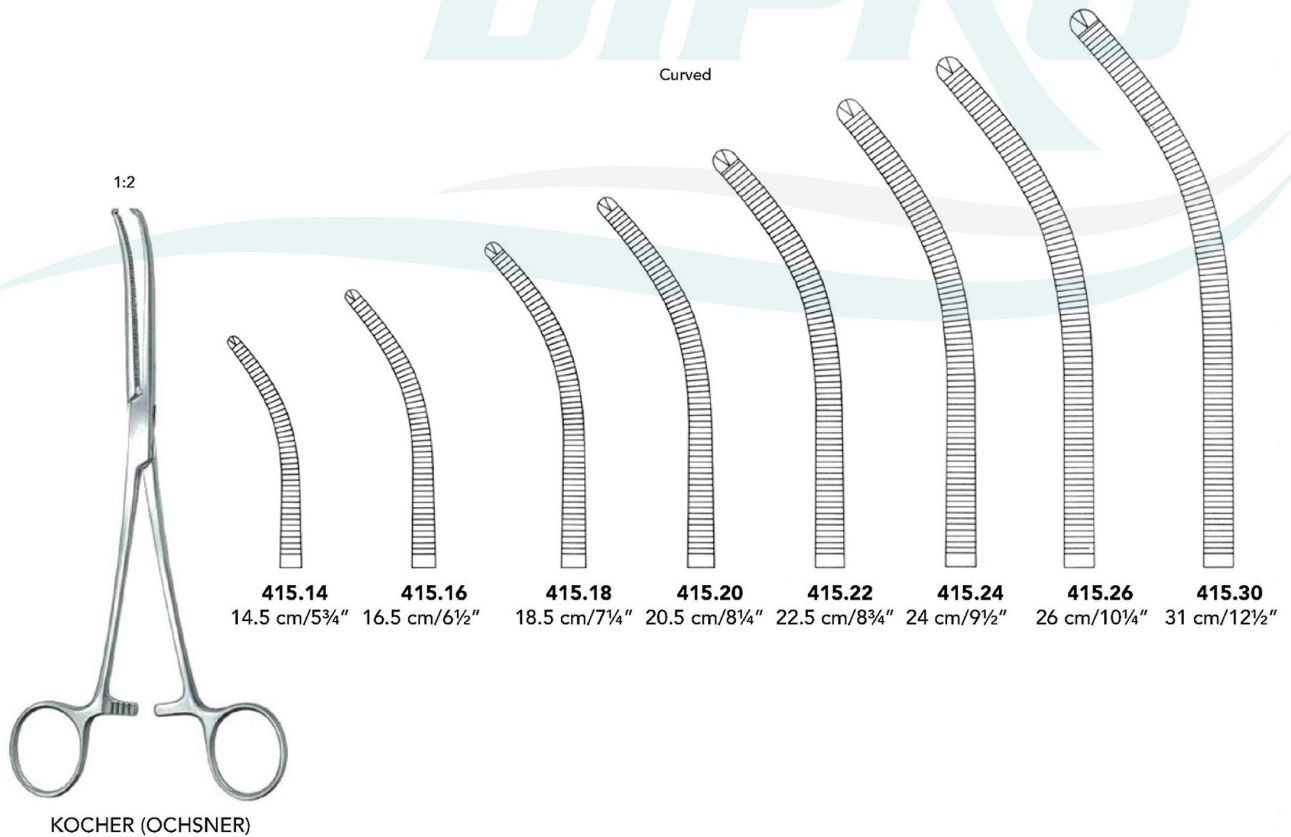

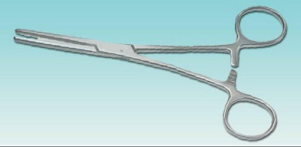

Haemostatic Forceps (Dissecting & Ligature Forceps)

	380.14 14.5 cm/5¾"	380.16 16.5 cm/6½"	380.18 18.0 cm/7"		382.14 14.5 cm/5¾"	382.16 16.5 cm/6½"	382.18 18.0 cm/7"
PEAN-NIPPON	381.14 14.5 cm/5¾"	381.16 16.5 cm/6½"	381.18 18.0 cm/7"	KOCHER-NIPPON	383.14 14.5 cm/5¾"	383.16 16.5 cm/6½"	383.18 18.0 cm/7"
	374.13 13.5 cm/5¼"	374.14 14.5 cm/5¾"	374.16 17 cm/6¾"		384.13 13 cm/5"	384.14 14 cm/5½"	384.16 16 cm/6¼"
PEAN	375.13 13.5 cm/5¼"	375.14 14.5 cm/5¾"	375.16 17 cm/6¾"	KOCHER	385.13 13 cm/5"	385.14 14 cm/5½"	385.16 16 cm/6¼"

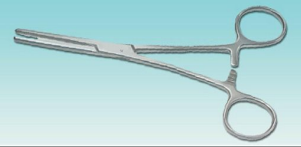

Haemostatic Forceps (Dissecting & Ligature Forceps)

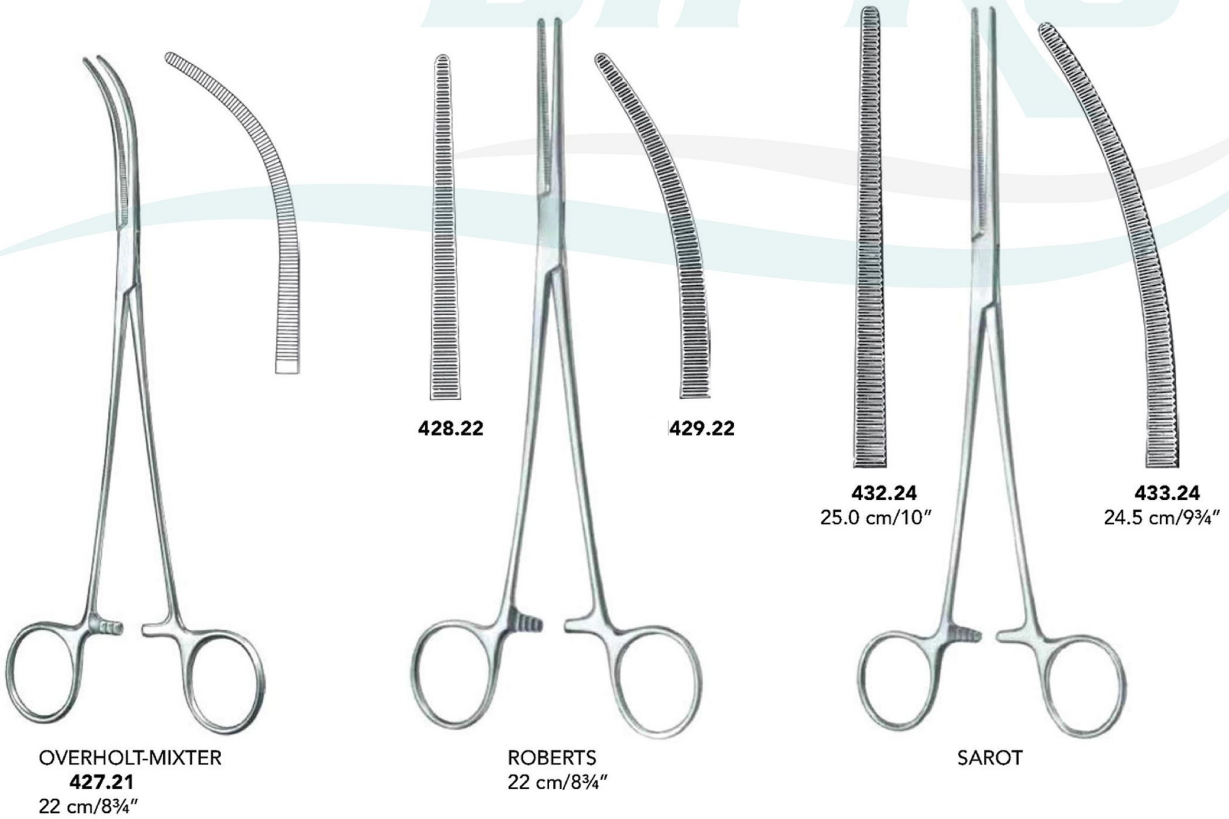
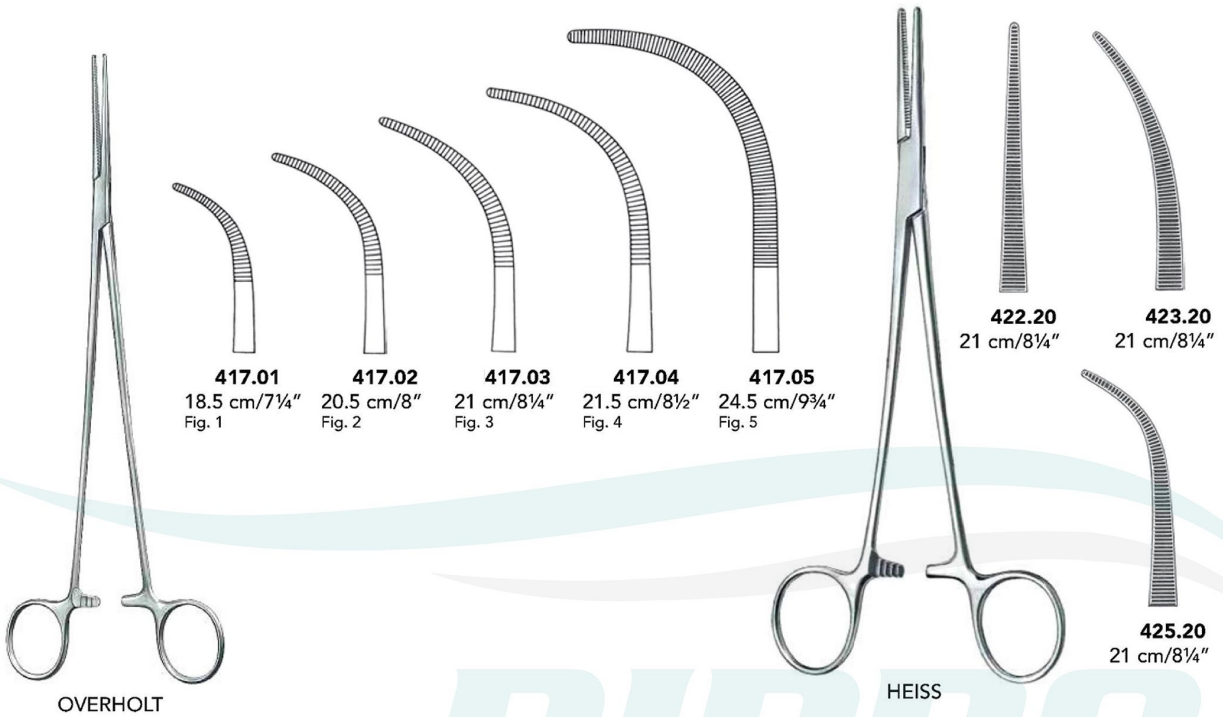

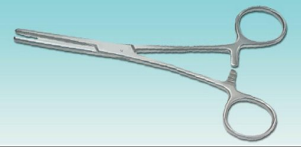

Haemostatic Forceps (Dissecting & Ligature Forceps)

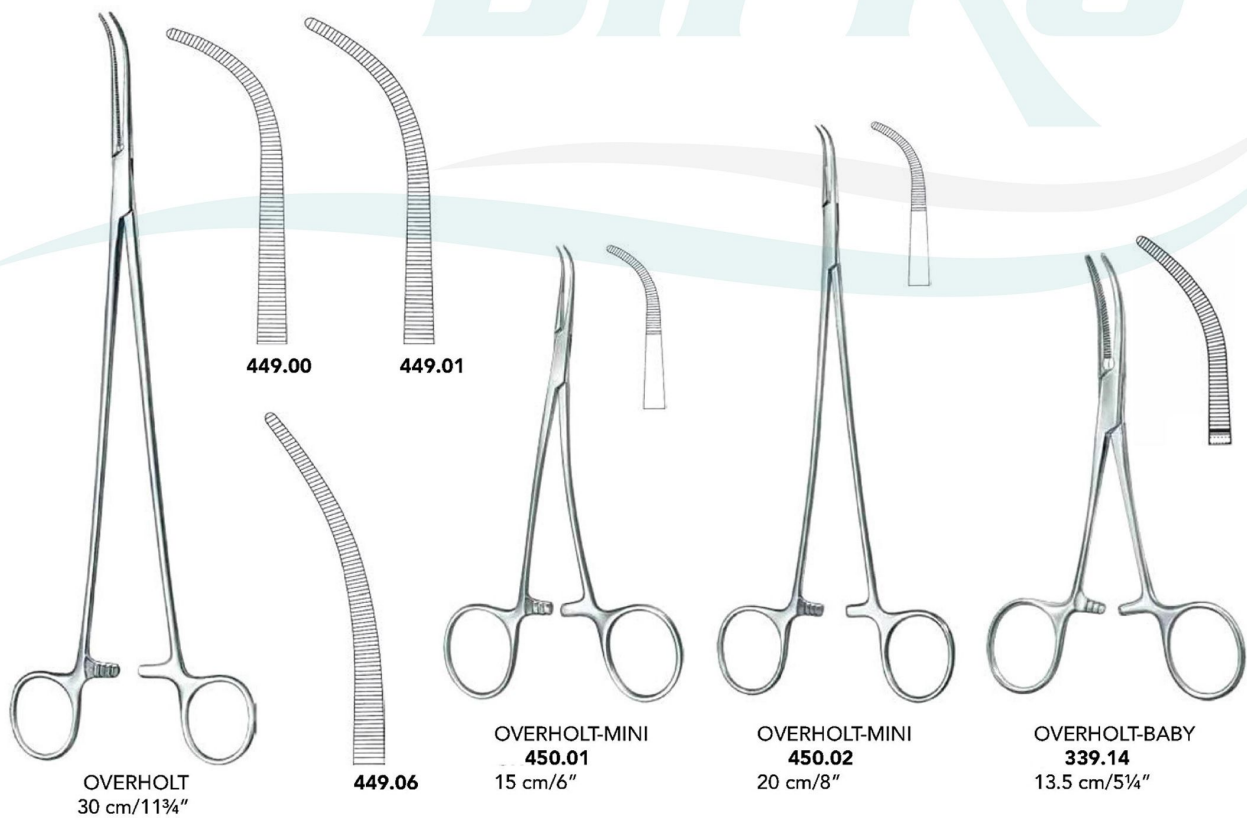
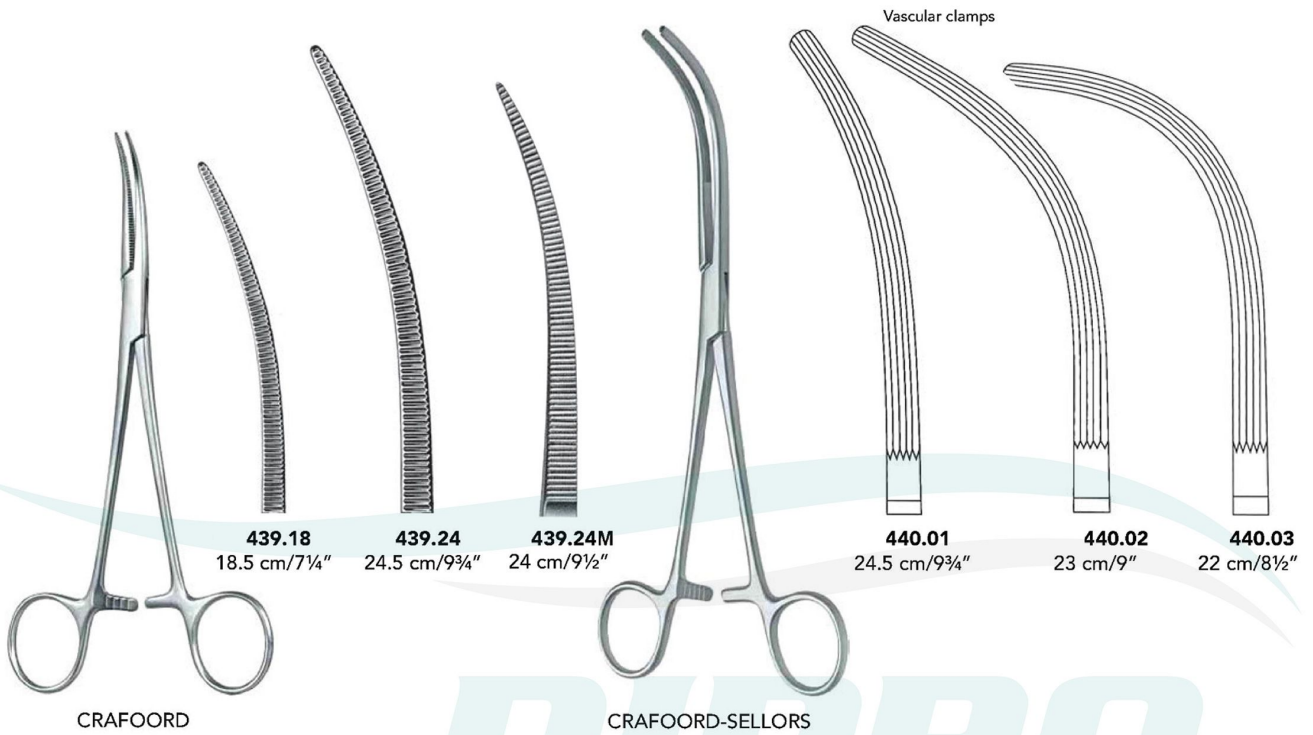

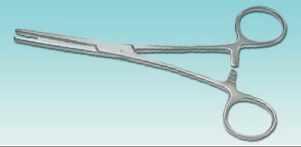

Haemostatic Forceps (Dissecting & Ligature Forceps)



OVERHOLT-FINO

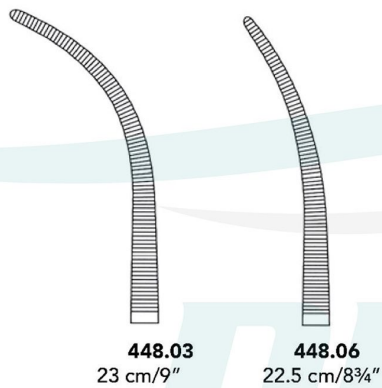
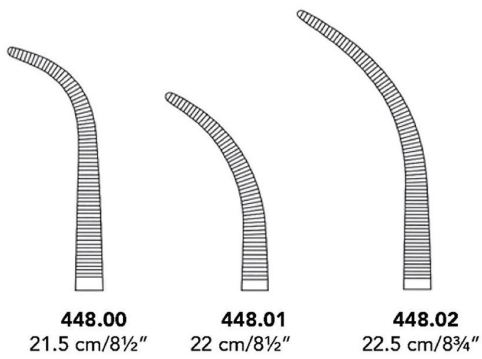

GEMINI

13 cm/5"	451.13
16 cm/6¼"	451.16
18 cm/7"	451.18
21 cm/8¼"	451.20
23 cm/9"	451.23
25 cm/10"	451.25
28 cm/11"	451.28



MINI-GEMINI

18 cm/7"	453.18
23 cm/9"	453.22
25 cm/10"	453.25
28.5 cm/11¼"	453.28



RUMEL
24 cm/9½"

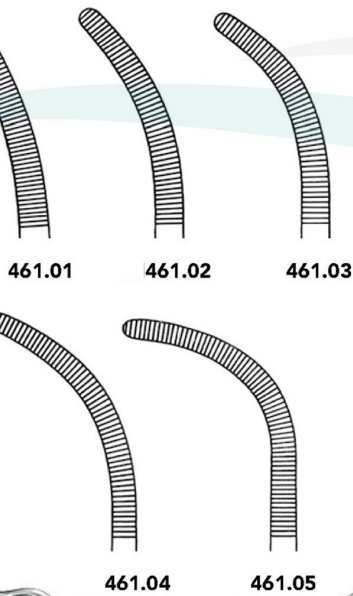

BENGOLEA

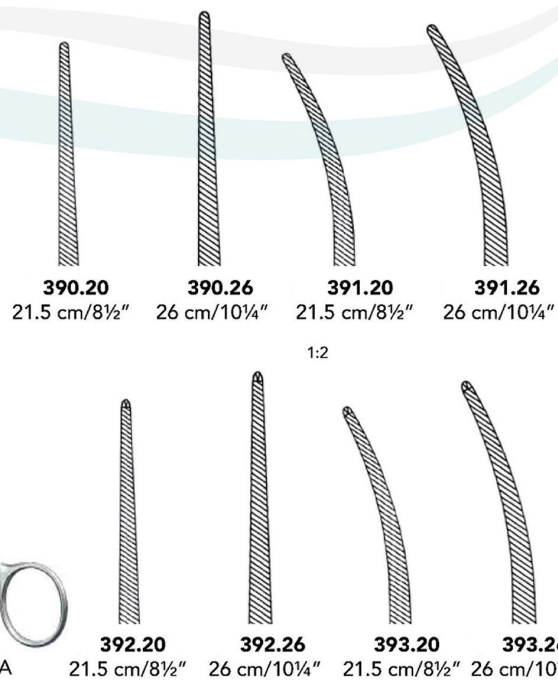

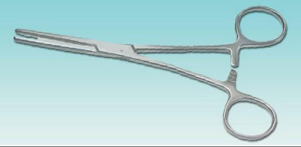

Haemostatic Forceps (Dissecting & Ligature Forceps)

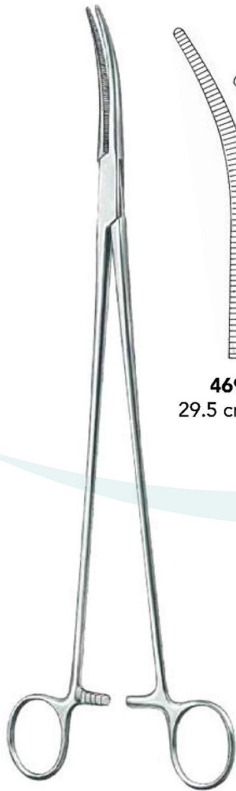

ZENKER

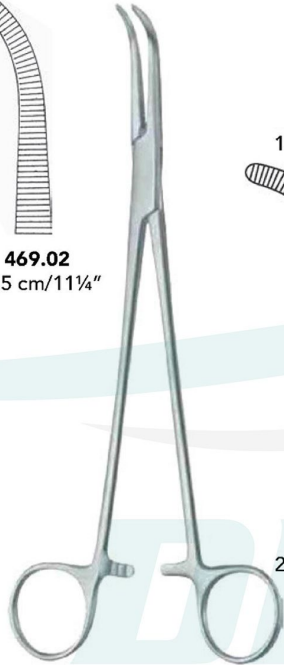
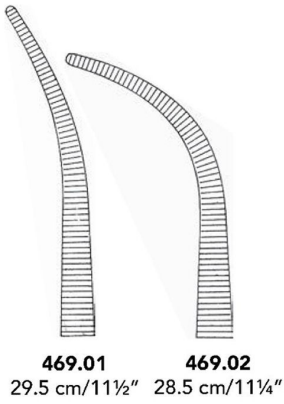

O'SHAUGHNESSY

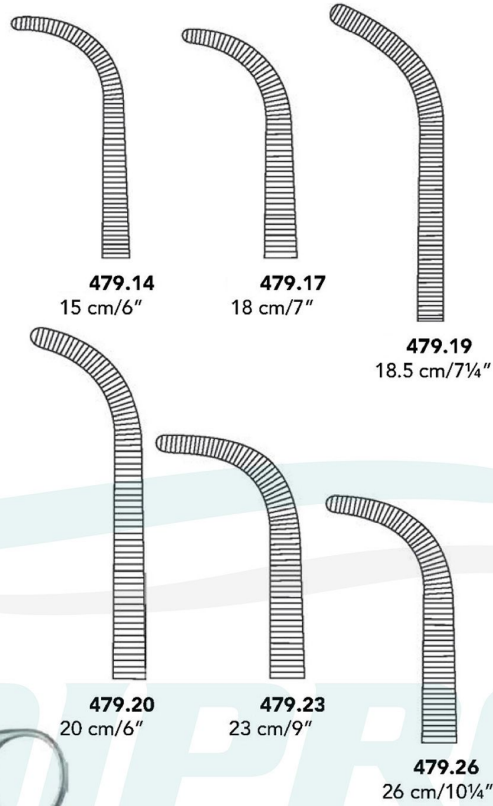

MIXTER-BABY
471.14
13 cm/5"

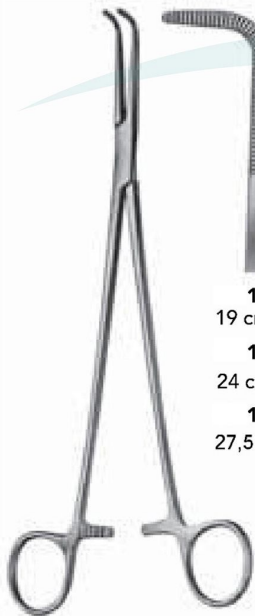

KANTROWITZ

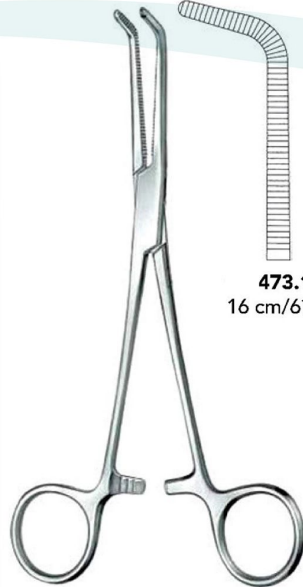

MIXTER

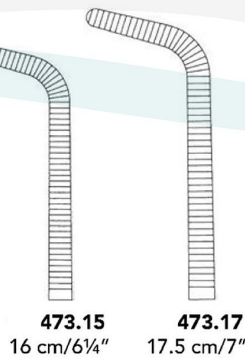

MIXTER-BABY
419.18
18.5 cm/7¼"

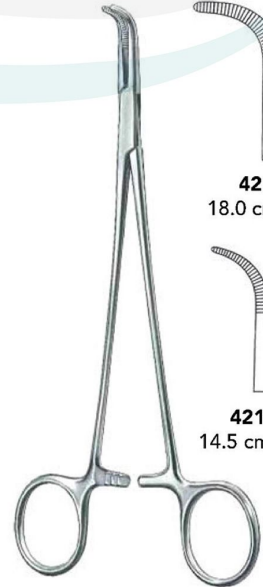

ADSON-BABY



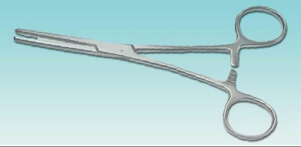

Haemostatic Forceps (Dissecting & Ligature Forceps)



483.22
22.5 cm/8¾"

MIXTER

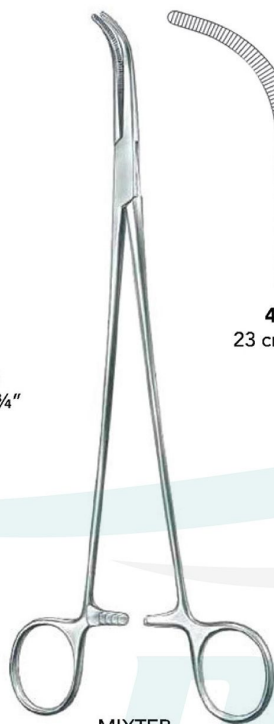

485.23
23 cm/9"

MIXTER

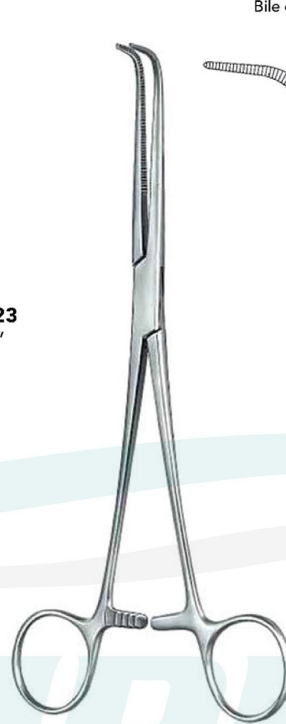

WIKSTROEM
21.0 cm/8¼" **487.21**
24.5 cm/9½" **487.24**

WIKSTROEM



MIXTER
22.5 cm/8¾" **491.22**
26 cm/10¼" **491.25**
28 cm/11" **491.28**

MIXTER

Bile duct clamps



MCQUIGG-MIXTER

497.22
23.5 cm/9¼"



MIXTER-BABY
13.5 cm/5¼"

303.01

303.02



Micro-ADSON
304.14
14 cm/5½"



BABY-ADSON
305.18
18 cm/7"

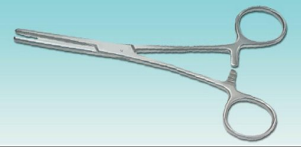

Haemostatic Forceps (Dissecting Forceps, Bile Duct Clamps)



LOWER
501.18
18.5 cm/7¼"



LAHEY

511.19
19.5 cm/7¾"

511.23
22.5 cm/8¾"



FINOCHIETTO

521.24
24.5 cm/9½"

Bile duct clamps

Tangential forceps

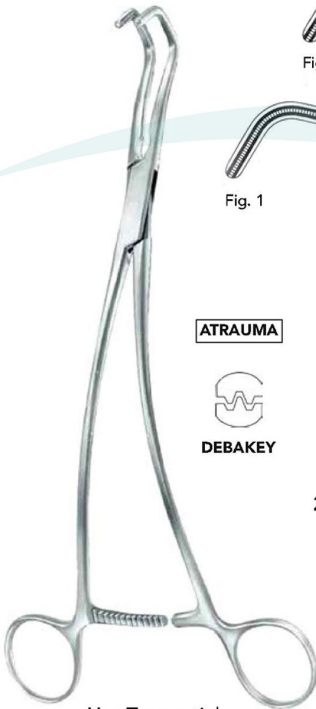

Uro-Tangential

ATRAUMA

DEBAKEY

Fig. 1

Fig. 2

527.01
25 cm/9¾"

527.02
26 cm/10¼"



GUYON

23 cm/9" **529.23**
24 cm/9½" **529.24**

ATRAUMA



DEBAKEY



GUYON

19.5 cm/9" **531.20**
21.5 cm/9½" **531.22**
24.5 cm/9½" **531.24**

Kidney pedicle clamps



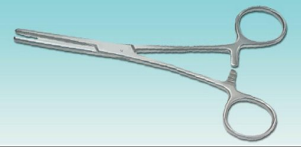

Haemostatic Forceps (Dissecting Forceps)

GUYON
533.23
23 cm/9"

DESJARDINS
571.21
21 cm/8¼"

KELLY

Bile Duct Clamp

	Fig. 1	Fig. 2	Fig. 3
19 cm/7½"	577.19	579.19	581.19
22.5 cm/9"	577.22	579.22	581.22
23 cm/9"	577.24	579.24	581.24

Hysterectomy forceps

Fig. 1
595.19
19 cm/7½"

Fig. 2
597.19
20 cm/8"

1:2
600.21
20.5 cm/8"

1:2
601.21
20.5 cm/8"

LAWRENCE
583.28
28 cm/11"

MEEKER
585.28
28 cm/11"

NEGUS

PHANEUF

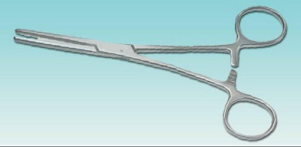

Haemostatic Forceps (Hysterectomy Forceps, Bile Duct Clamps)



Fig. 1



Fig. 2

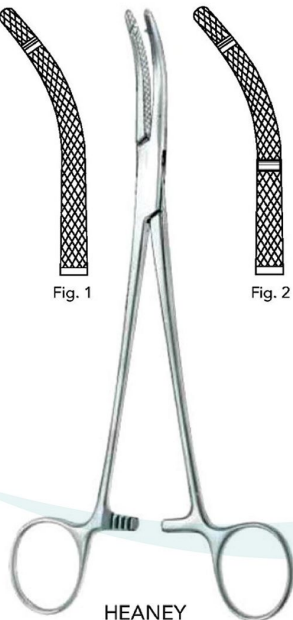

HEANEY

	Fig. 1	Fig. 2
19.5 cm/7"	613.19	615.19
21.0 cm/8¼"	613.21	615.21
23.0 cm/9"	613.23	615.23



Vaginal clamp



WERTHEIM-CULLEN
625.21
21 cm/8¼"



MOYNIHAN

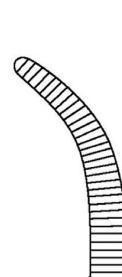

671.23
23 cm/9"

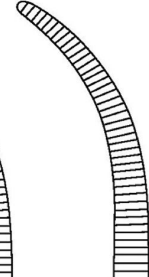

673.24
24 cm/9½"



ROGERS

ATRAUMA
DEBAKEY

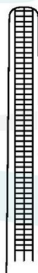

Fig. 1

635.10
21.5 cm/8½"



Fig. 2

635.20
21 cm/8¼"



Fig. 3

635.30
21 cm/8¼"

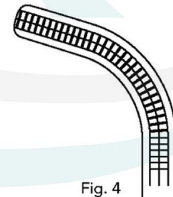

Fig. 4

635.40
20.5 cm/8"

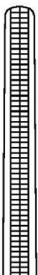

Fig. 1

637.10
25.5 cm/10"

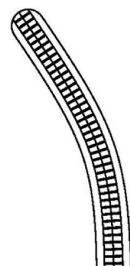

Fig. 2

637.20
25 cm/9¾"

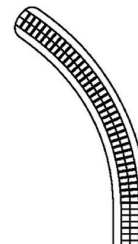

Fig. 3

637.30
24.5 cm/9½"

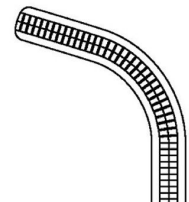
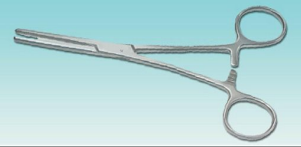

Fig. 4

637.40
24.5 cm/9½"



Haemostatic Forceps (Hysterectomy & Peritoneum Forceps)



WERTHEIM
697.25
26 cm/10¼"

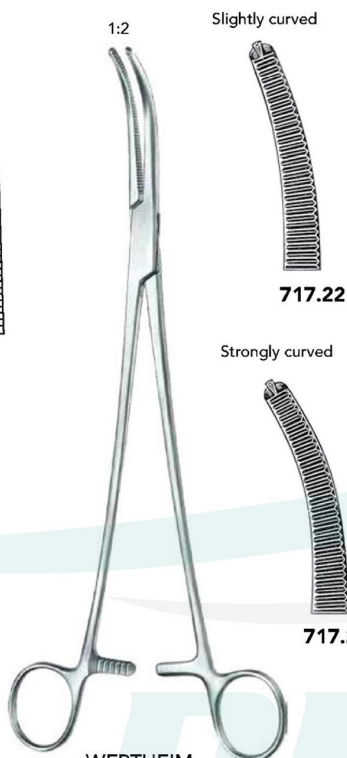

WERTHEIM
717.22
22.5 cm/18¾"



717.23

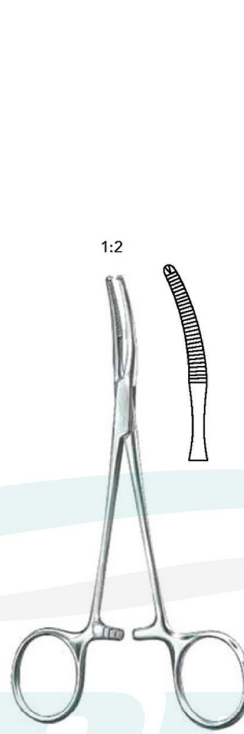

MIKULICZ-BABY
721.14
14.5 cm/5¾"

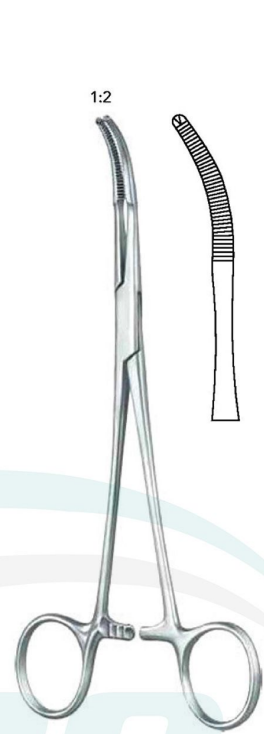

MIKULICZ
725.18
18.5 cm/7¼"



MIKULICZ
727.20
20 cm/8"

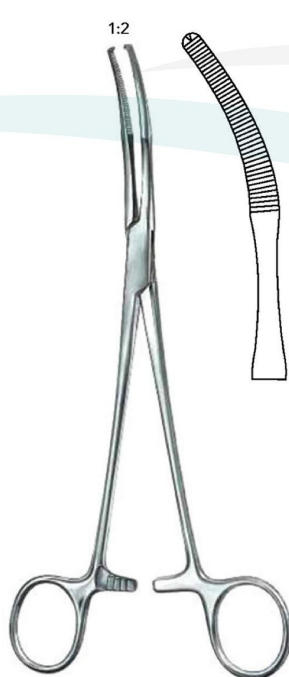

MIKULICZ
745.20
20 cm/8"

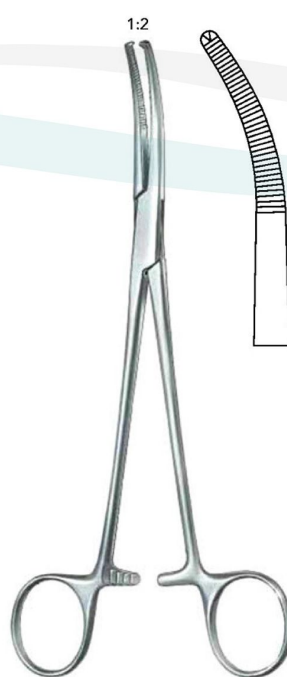

MIKULICZ
749.21
20.5 cm/8¼"

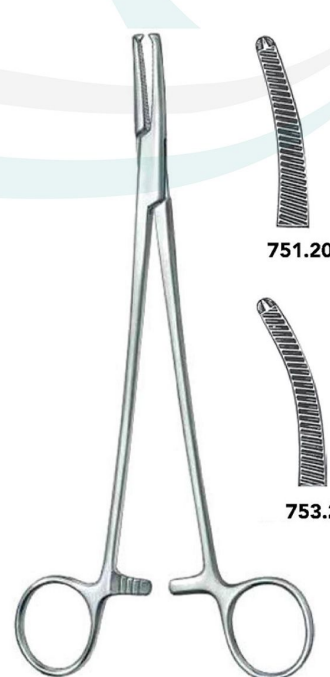

751.20



753.20

FAURE
21 cm/8¼"

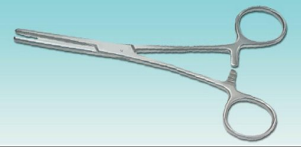

Haemostatic Forceps (Towel Clamps)



SCHAEFFEL
875.09
9 cm/3½"



JONES
881.05 5.5 cm/2¼"
881.09 8.5 cm/3½"



JONES
883.09
8.5 cm/3½"



BACKHAUS
915.09 9 cm/3½"
915.11 11 cm/4½"
915.13 13 cm/5¼"
915.15 16 cm/6¼"

DIPRO

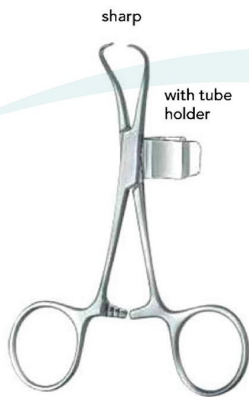

BACKHAUS
913.11
11 cm/4½"



BACKHAUS
909.11 11 cm/4½"
909.13 13 cm/5¼"



BERNHARD
921.16
16.5 cm/6½"



ROEDER
917.13
13.5 cm/5¼"

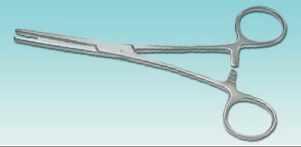

Haemostatic Forceps (Towel Clamps)

fine serration wide jaw



LORNA
919.10 10 cm/4"
919.13 13 cm/5"



JACKSON
1000.03
Tendon tutucu pens
Tendon seizing forceps
4 x 5 disj/4 x 5 teeth
15 cm

for paper drapes

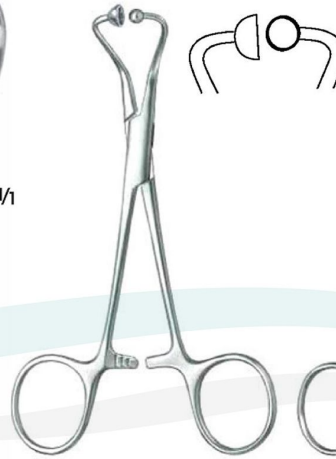

BALL & SOCKET
924.11 11.5 cm/4½"
924.14 14.0 cm/5½"

blunt

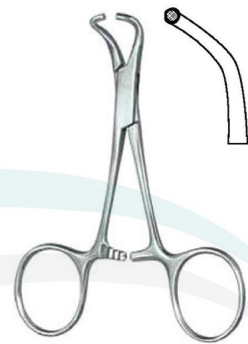

TOHOKU
923.10 10.5 cm/4¼"
923.13 13.5 cm/5¼"

wide jaw for tube fixation



PEERS-BERTRAM
923.14
14.5 cm/5¾"



PEERS-BERTRAM modif.
916.15
14.5 cm/5¾"



LANE
935.20
19.5 cm/7¾"

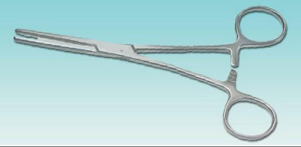

Haemostatic Forceps (Tubing Clamps)

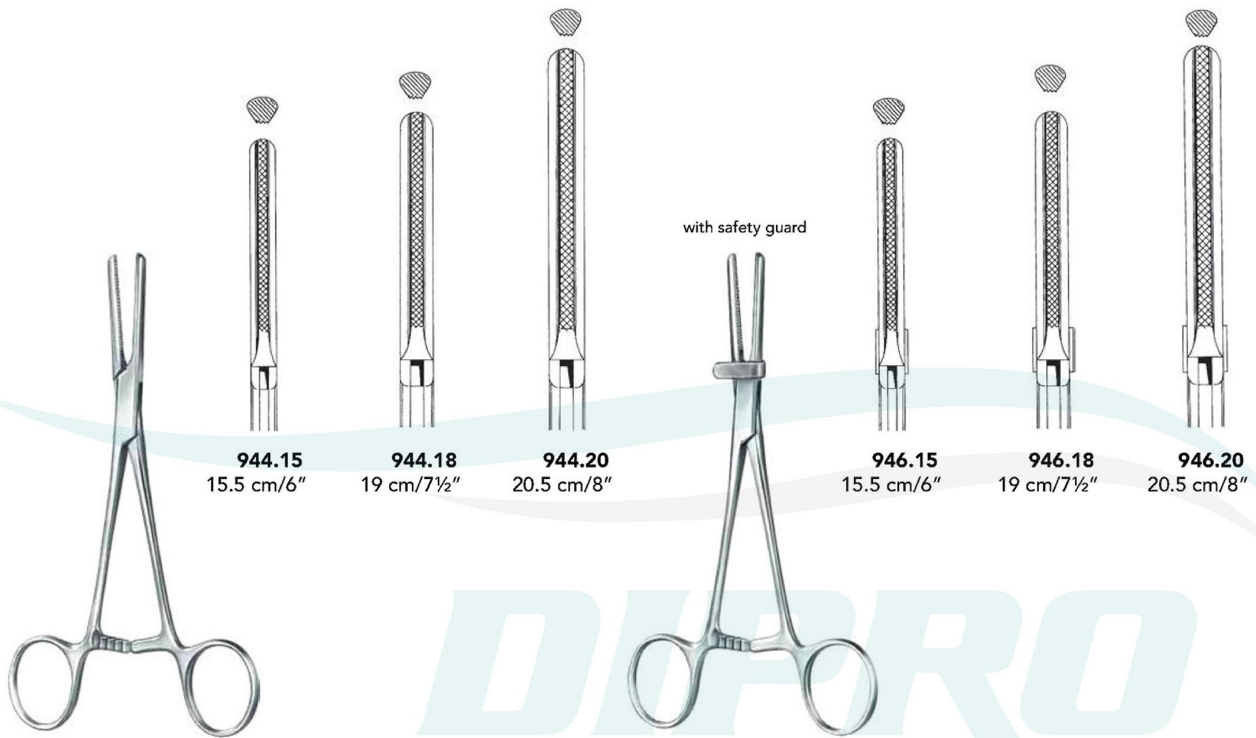

944.15
15.5 cm/6"

944.18
19 cm/7½"

944.20
20.5 cm/8"

with safety guard

946.15
15.5 cm/6"

946.18
19 cm/7½"

946.20
20.5 cm/8"

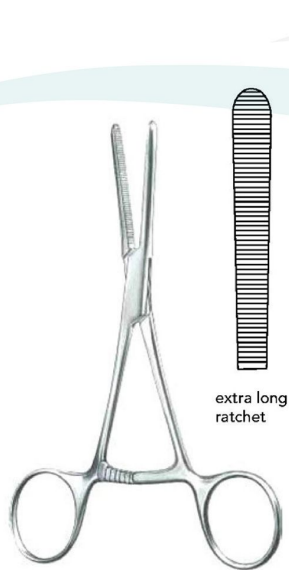

extra long
ratchet

940.14
14 cm/5½"

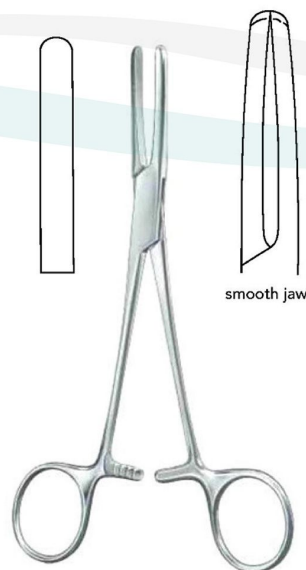

smooth jaw

942.16
16.5 cm/6½"