



**Gynecology (Vaginal Specula)**



CUSCO

<b>110.01</b>	75 x 32 mm
<b>110.02</b>	85 x 37 mm
<b>110.03</b>	100 x 35 mm
<b>114.01</b>	90 x 22 mm
<b>114.02</b>	100 x 25 mm
<b>114.03</b>	105 x 27 mm



CUSCO

<b>112.01</b>	75 x 18 mm
---------------	------------



SEYFFERT

<b>1000.04</b>	100 x 17 mm
<b>1000.05</b>	100 x 33 mm
<b>1000.06</b>	110 x 33 mm (one side def.)

23 cm



CUSCO

<b>116.01</b>	75 x 34 mm
<b>116.02</b>	85 x 37 mm
<b>116.03</b>	100 x 37 mm

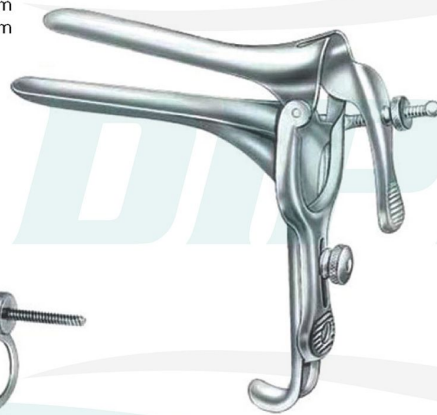

PEDERSON

<b>128.01</b>	75 x 13 mm
<b>128.02</b>	100 x 24 mm
<b>128.03</b>	120 x 28 mm



GRAVE

<b>130.01</b>	75 x 20 mm
<b>130.02</b>	95 x 35 mm
<b>130.03</b>	115 x 35 mm

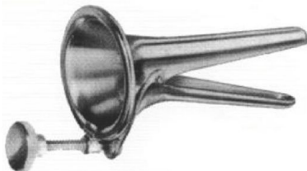

COLLIN

<b>120.01 S</b>	53 x 10 mm
-----------------	------------



COLLIN

<b>120.01</b>	85 x 30 mm
<b>120.02</b>	100 x 35 mm
<b>120.03</b>	110 x 40 mm



SEMM

<b>132.01</b>	100 x 20-25 mm
<b>132.02</b>	100 x 27-35 mm



**Gynecology (Vaginal Specula & Retractors)**



**TRELAT**  
**1000.11** 85 x 33 mm  
**1000.12** 95 x 35 mm  
**1000.13** 115 x 43 mm



**KRISTELLER**  
**182.01** 70 x 27 mm Fig. 1  
**182.02** 80 x 30 mm Fig. 2  
**182.03** 90 x 36 mm Fig. 3

**KRISTELLER**  
**183.01** 70 x 23 mm Fig. 1  
**183.02** 85 x 26 mm Fig. 2  
**183.03** 100 x 32 mm Fig. 3

**KRISTELLER**  
**185.01** Fig. 1 ( 182.01), ( 183.01)  
**185.02** Fig. 2 ( 182.02), ( 183.02)  
**185.03** Fig. 3 ( 182.03), ( 183.03)



**KRISTELLER**  
**190.01** 105 x 18 mm Fig. 1  
**190.02** 110 x 21 mm Fig. 2

**KRISTELLER**  
**191.01** 110 x 14 mm Fig. 1  
**191.02** 115 x 17 mm Fig. 2

**KRISTELLER**  
**195.01** Fig. 1 ( 190.01), ( 191.01)  
**195.02** Fig. 2 ( 190.02), ( 191.02)



**Gynecology (Vaginal Specula & Retractors)**



flat speculum

KRISTELLER		
<b>196.01</b>	105 x 26 mm	Fig. 1
<b>196.02</b>	105 x 28 mm	Fig. 2
<b>196.03</b>	105 x 33 mm	Fig. 3



flat speculum

KRISTELLER		
<b>197.01</b>	115 x 22 mm	Fig. 1
<b>197.02</b>	115 x 24 mm	Fig. 2
<b>197.03</b>	115 x 29 mm	Fig. 3



flat speculum

KRISTELLER		
<b>199.01</b>	Fig. 1 (	196.01), ( 197.01)
<b>199.02</b>	Fig. 2 (	196.02), ( 197.02)
<b>199.03</b>	Fig. 3 (	196.03), ( 197.03)

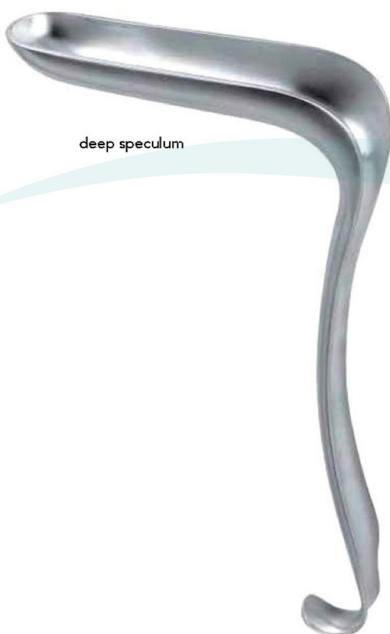

deep speculum

KRISTELLER		
<b>202.01</b>	110 x 28 mm	Fig. 1
<b>202.02</b>	110 x 30 mm	Fig. 2
<b>202.03</b>	110 x 36 mm	Fig. 3

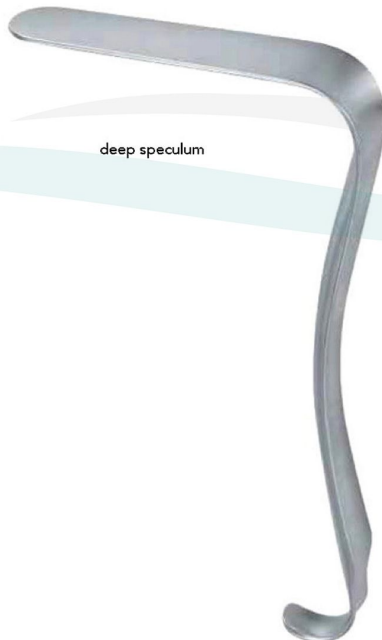

deep speculum

KRISTELLER		
<b>203.01</b>	115 x 23 mm	Fig. 1
<b>203.02</b>	115 x 26 mm	Fig. 2
<b>203.03</b>	115 x 32 mm	Fig. 3



deep speculum

KRISTELLER		
<b>205.01</b>	Fig. 1 (	202.01), ( 203.01)
<b>205.02</b>	Fig. 2 (	202.02), ( 203.02)
<b>205.03</b>	Fig. 3 (	202.03), ( 203.03)



**Gynecology (Vaginal Specula & Retractors)**



**KALLMORGEN**  
**232.01** 70 x 40 mm Fig. 1  
**232.02** 90 x 40 mm Fig. 2



**KALLMORGEN**  
**233.01** 70 x 37 mm Fig. 1  
**233.02** 90 x 37 mm Fig. 2



**KALLMORGEN**  
**235.01** Fig. 1 ( 232.01), ( 232.01)  
**235.02** Fig. 2 ( 232.02), ( 232.02)



**SIMS**  
**160.01** 65 x 25 / 70 x 30 mm  
**160.02** 65 x 25 / 80 x 35 mm  
**160.03** 65 x 25 / 90 x 40 mm



**JACKSON**  
**165.01** 75 x 38 mm  
**165.02** 90 x 38 mm  
**165.03** 100 x 38 mm





**Gynecology (Vaginal Specula & Retractors)**



|||

**DOYEN**

<b>249.01</b>	58 x 35 mm
<b>249.02</b>	88 x 35 mm
<b>249.03</b>	118 x 35 mm
<b>250.01</b>	60 x 47 mm
<b>250.02</b>	78 x 47 mm
<b>250.03</b>	120 x 47 mm
<b>250.04</b>	165 x 47 mm
<b>251.01</b>	55 x 60 mm
<b>251.02</b>	85 x 60 mm
<b>251.03</b>	115 x 60 mm

**BREISKY**

<b>323.20</b>	100 x 20 mm	29.5 cm/11½"
<b>323.25</b>	100 x 25 mm	29.5 cm/11½"
<b>323.30</b>	100 x 30 mm	29.5 cm/11½"
<b>323.35</b>	100 x 35 mm	29.5 cm/11½"
<b>323.40</b>	100 x 40 mm	29.5 cm/11½"
<b>324.20</b>	130 x 20 mm	32.0 cm/12¾"
<b>324.25</b>	130 x 25 mm	32.0 cm/12¾"
<b>324.30</b>	130 x 30 mm	32.0 cm/12¾"
<b>324.35</b>	130 x 35 mm	32.0 cm/12¾"
<b>324.40</b>	130 x 40 mm	32.0 cm/12¾"
<b>325.40</b>	160 x 40 mm	35.0 cm/14"

**DOYEN**

<b>342.24</b>	25 cm/10"
---------------	-----------



**Gynecology (Endocervical Specula, Uterine Dilators)**

Uterine Dilators

Endocervical Specula



**KOGAN**  
**381.24**  
24.5 cm/9½"



**KOGAN**  
**383.24**  
24.5 cm/9½"



**GOODELL**  
**383.34**  
34 cm/13½"



**Gynecology (Uterine Dilators)**



HEGAR  
18.5 cm/7¼"

	Diameter
400.01	Ø 1.0 mm
400.02	Ø 2.0 mm
400.03	Ø 3.0 mm
400.04	Ø 4.0 mm
400.05	Ø 5.0 mm
400.06	Ø 6.0 mm
400.07	Ø 7.0 mm
400.08	Ø 8.0 mm
400.09	Ø 9.0 mm
400.10	Ø 10.0 mm
400.11	Ø 11.0 mm
400.12	Ø 12.0 mm
400.13	Ø 13.0 mm
400.14	Ø 14.0 mm
400.15	Ø 15.0 mm
400.16	Ø 16.0 mm
400.17	Ø 17.0 mm
400.18	Ø 18.0 mm
400.19	Ø 19.0 mm
400.20	Ø 20.0 mm
400.21	Ø 21.0 mm
400.22	Ø 22.0 mm
400.23	Ø 23.0 mm
400.24	Ø 24.0 mm
400.25	Ø 25.0 mm
400.26	Ø 26.0 mm

	Diameter
401.01	Ø 1.5 mm
401.02	Ø 2.5 mm
401.03	Ø 3.5 mm
401.04	Ø 4.5 mm
401.05	Ø 5.5 mm
401.06	Ø 6.5 mm
401.07	Ø 7.5 mm
401.08	Ø 8.5 mm
401.09	Ø 9.5 mm
401.10	Ø 10.5 mm
401.11	Ø 11.5 mm
401.12	Ø 12.5 mm
401.13	Ø 13.5 mm
401.14	Ø 14.5 mm
401.15	Ø 15.5 mm
401.16	Ø 16.5 mm
401.17	Ø 17.5 mm

**400.80**  
set of 14 pieces (full sizes) from 4,0 to 17,0 mm without case

**400.84**  
set of 14 pieces (full sizes) from 4,0 to 17,0 mm in metal case

**400.90**  
set of 26 pieces (full sizes) from 1,0 to 26,0 mm without case

**400.98**  
metal case only, for Ø 4-17 mm



HEGAR  
20 cm/8"

	Diameter
430.02	Ø 1.0 / 2.0 mm
430.04	Ø 3.0 / 4.0 mm
430.06	Ø 5.0 / 6.0 mm
430.08	Ø 7.0 / 8.0 mm
430.10	Ø 9.0 / 10 mm
430.12	Ø 11 / 12 mm
430.14	Ø 13 / 14 mm
430.16	Ø 15 / 16 mm
430.18	Ø 17 / 18 mm
430.20	Ø 19 / 20 mm
430.22	Ø 21 / 22 mm
430.24	Ø 23 / 24 mm
430.26	Ø 25 / 26 mm



**430.82 (Set of 8)**  
(Ø 3.0 / 4.0 to 17.0 / 18.0 mm)  
in canvas roll

**430.80 (Set of 8)**  
(Ø 3.0 / 4.0 to Ø 17.0 / 18.0 mm)  
without canvas roll

**430.86 (Set of 13)**  
(Ø 1.0 / 2.0 to Ø 25 / 26 mm)  
with canvas roll



**Gynecology (Uterine Dilators)**

American scale

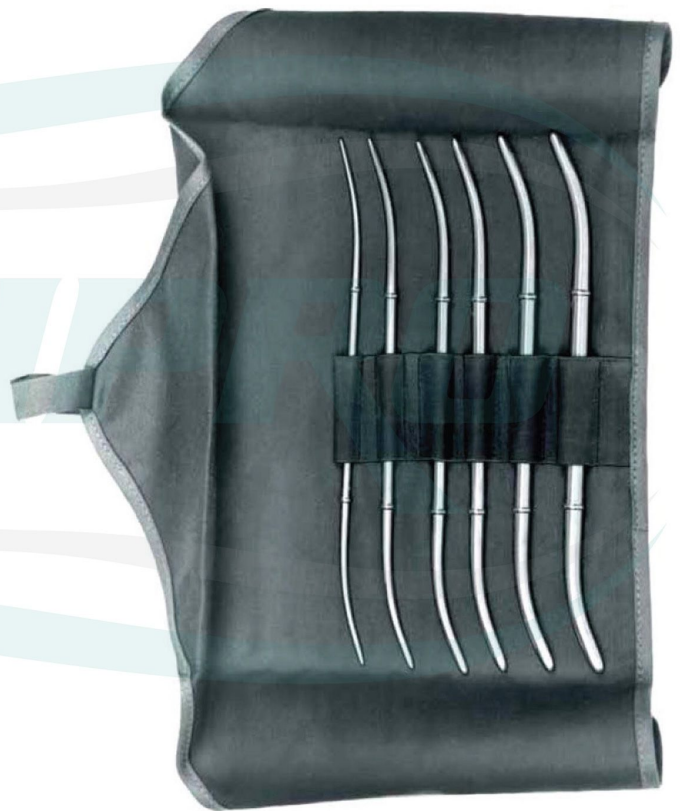

**HANK**  
26.5 cm/10½"

	Diameter	Fig
<b>460.10</b>	Ø 4.5 / 5.0 mm	9 / 10
<b>460.12</b>	Ø 5.5 / 6.0 mm	11 / 12
<b>460.14</b>	Ø 6.5 / 7.0 mm	13 / 14
<b>460.16</b>	Ø 7.5 / 8.0 mm	15 / 16
<b>460.18</b>	Ø 8.5 / 9.0 mm	17 / 18
<b>460.20</b>	Ø 9.5 / 10 mm	19 / 20

**460.82**  
set of 6 Pices in boilable canvas roll





**Gynecology (Uterine Sounds, Uterine Depressor)**

Ø 4 mm  
rigid



SIMS  
**583.32**  
33 cm/13"

Ø 4 mm  
malleable



SIMS  
**584.32**  
33 cm/13"

Ø 4 mm



VALLEIX  
**593.25**  
27 cm/10½"

Uterine Depressor



BRAUN  
**596.26**  
27 cm/10½"



**Gynecology (Uterine Tenaculum Forceps, Amniotome)**

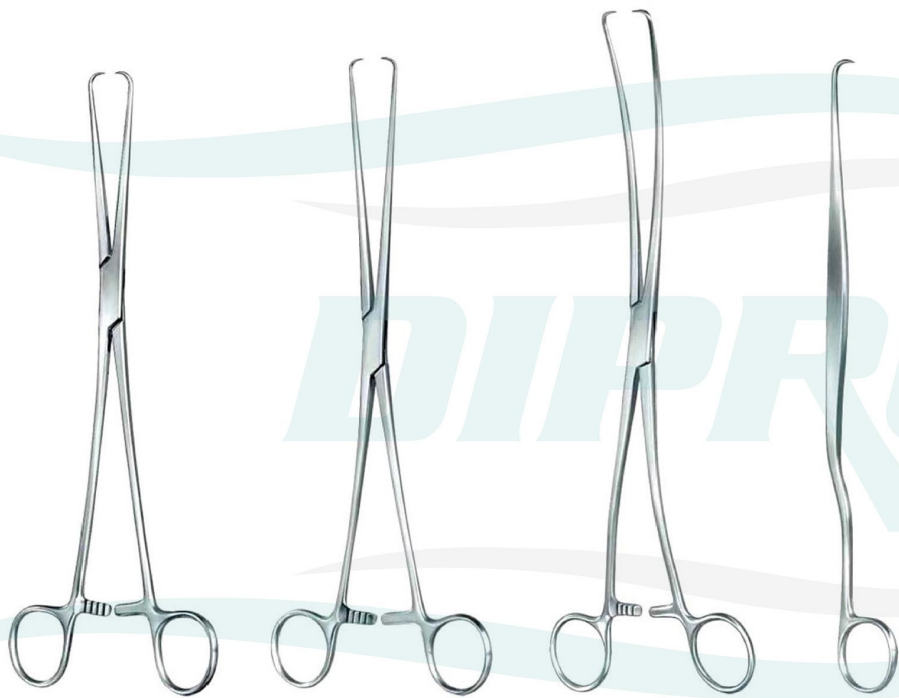

SCHROEDER  
**622.25**  
25 cm/10"

BRAUN  
**628.25**  
25 cm/10"

DUPLAY  
**645.28**  
28 cm/11"

BEACHAM  
**659.26**  
26 cm/10¼"



**Gynecology (Uterine Tenaculum Forceps)**





**Gynecology (Uterine Tenaculum Forceps)**

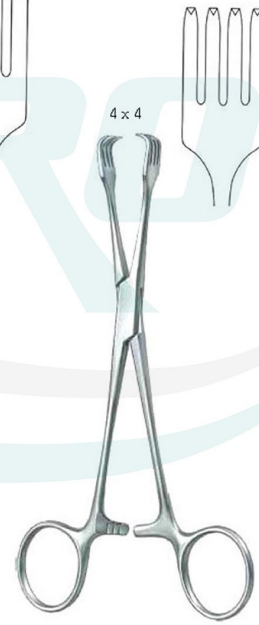
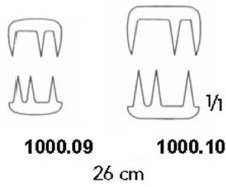

MUSEUX  
24 cm/9½"

734.26  
26.5 cm/10½"

CZERNY  
740.21  
21 cm/8¼"

BRAUN  
738.16  
16 cm/6¼"



**Gynecology (Uterine Polypus Forceps)**

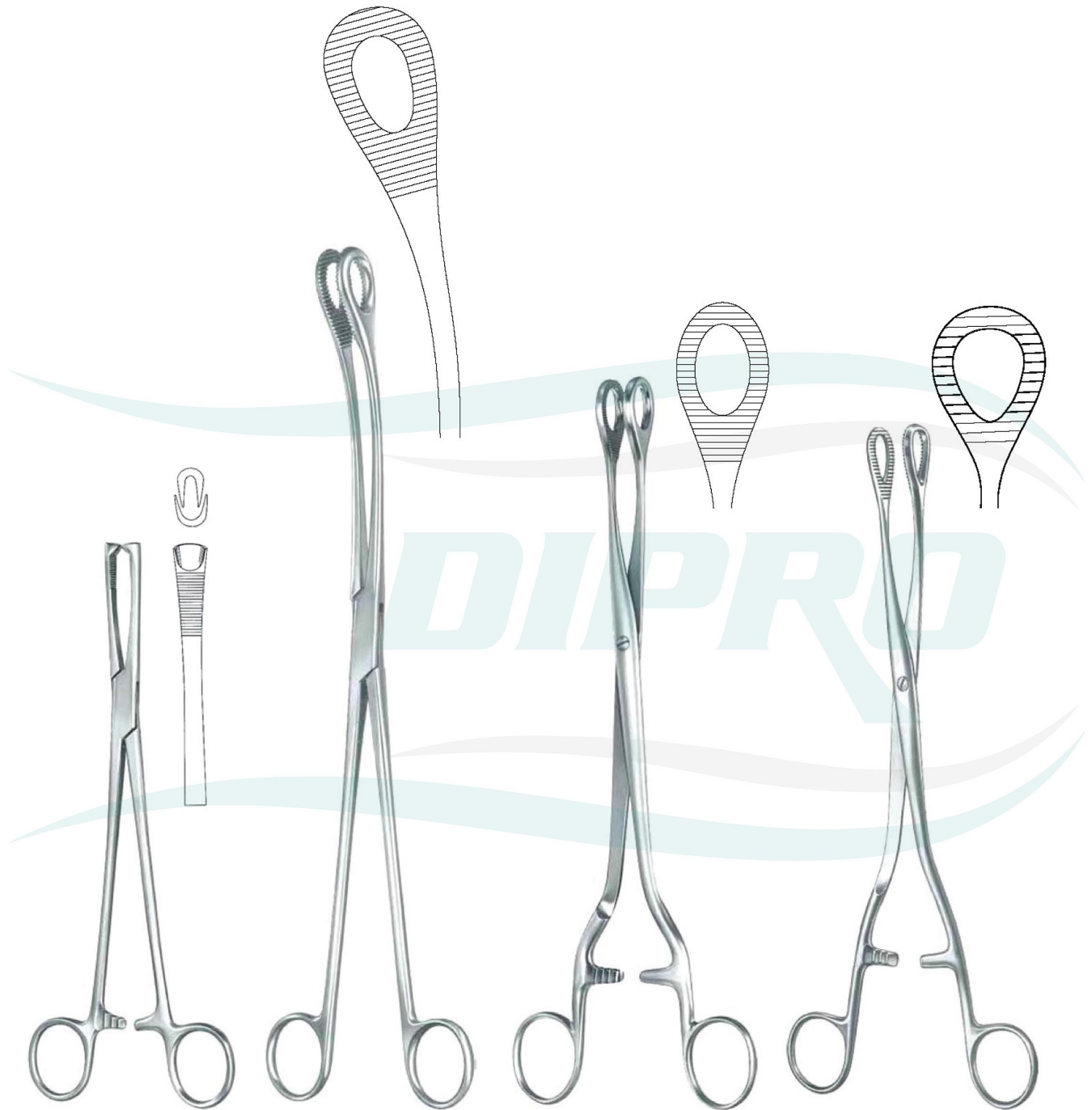

JACOBS  
**728.21**  
21 cm/8¼"

KELLY  
**741.32**  
31.5 cm/12¾"

NOTO  
**744.27**  
27 cm/10½"

HEYWOOD-SMITH  
**745.25**  
26 cm/10¼"  
**1000.01**  
20 cm/8"



**Gynecology (Uterine Seizing Forceps)**

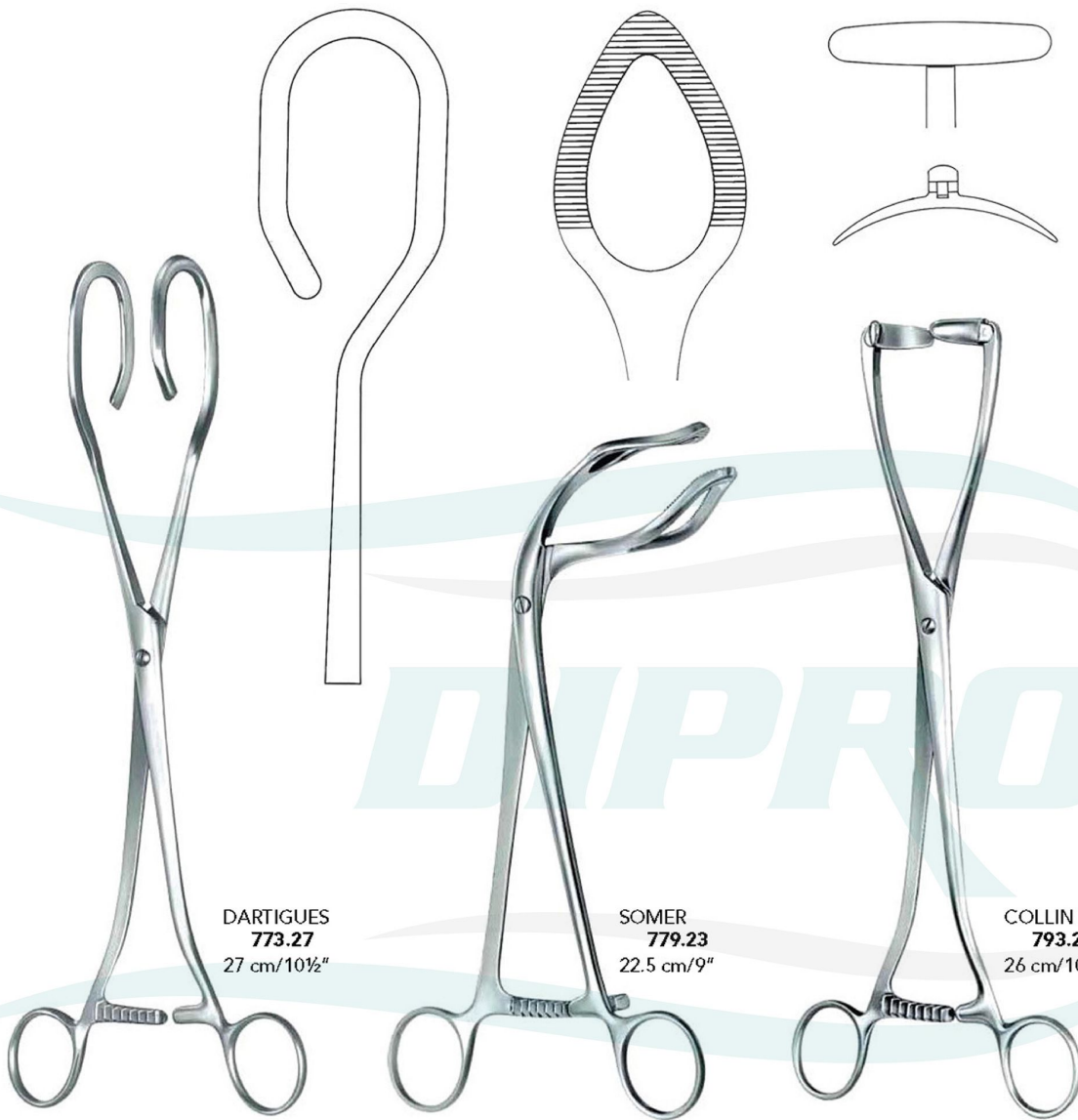

**DARTIGUES**  
**773.27**  
27 cm/10½"

**SOMER**  
**779.23**  
22.5 cm/9"

**COLLIN**  
**793.25**  
26 cm/10¼"



**COLLIN**  
**1000.00**  
28,5 cm



**Gynecology (Fistula Hooks, Suction Curettes)**

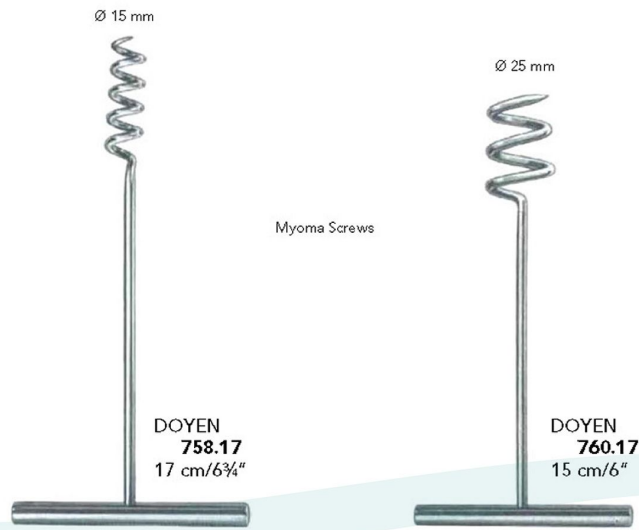

Conization Knife



AYRE  
**801.23**  
23.5 cm/9¼"



EMMETT  
**804.03**  
23 cm/9"



SIMON  
**806.22**  
21.5 cm/8½"



SIMON  
**808.22**  
21.5 cm/8½"



SEGOND  
**762.27**  
28 cm/11"

Ø 4 mm

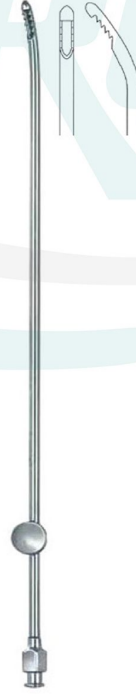

NOVAK  
**825.23**  
24.5 cm/9½"



KEVORKIAN  
**827.30**  
30 cm/11¾"

Myoma Knife

Suction Curettes





**Gynecology (Uterine Biopsy Forceps)**



1000.15



1000.16



SCHUMACHER  
1000.15- 1000.16  
24 cm

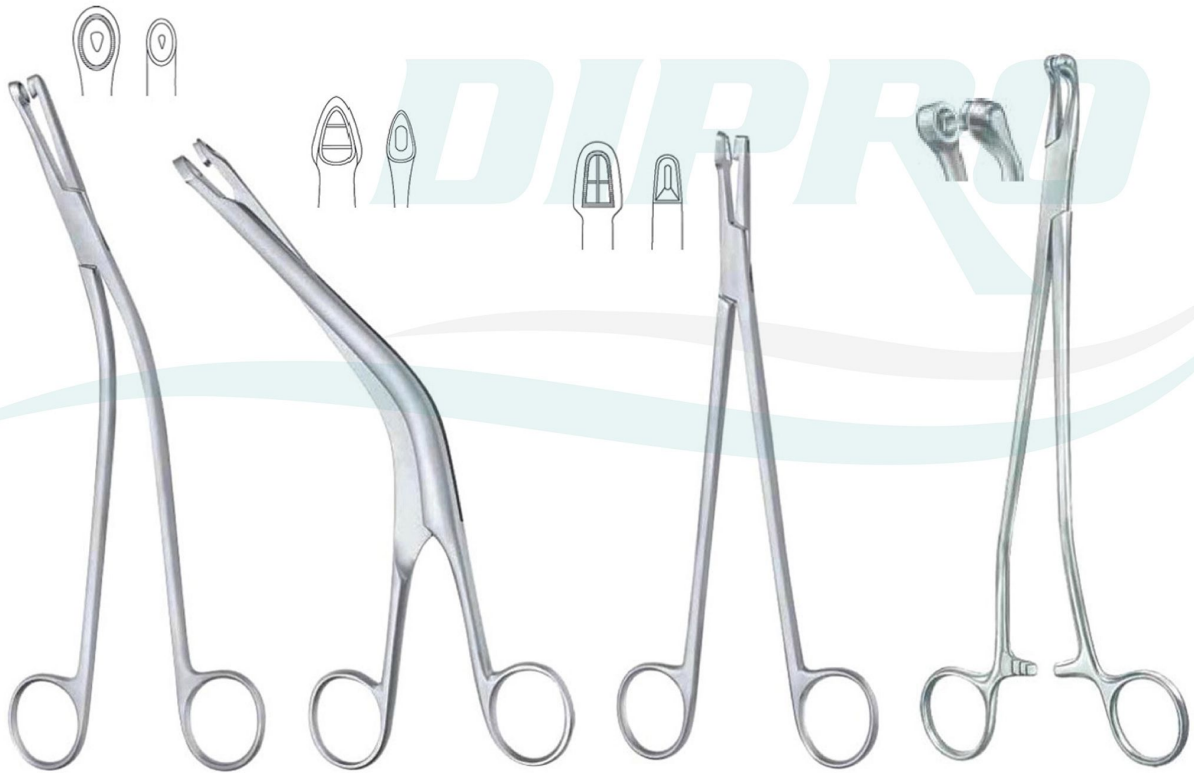

GELLHORN  
841.23  
24 cm/9½"

FAURE  
843.21  
21 cm/8¼"

SCHUBERT  
846.21 21.5 cm/8½"  
846.28 28.0 cm/11"

THOMS-GAYLOR  
851.22 21 cm/8¼"  
851.24 24.0 cm/9"





**Gynecology (Uterine Biopsy Forceps)**



**SCHUBERT**  
853.26  
24 cm/9½"



**SCHULZE**  
1000.14  
37.5 cm

**SCHULZE**  
100.14 Komplet/Complete



**VANDOREN**  
855.24  
27 cm/10½"

**VAN DOREN**  
855.25  
25.5 cm/10"



**Gynecology (Uterine Biopsy Forceps, IUP Grasping Forceps)**

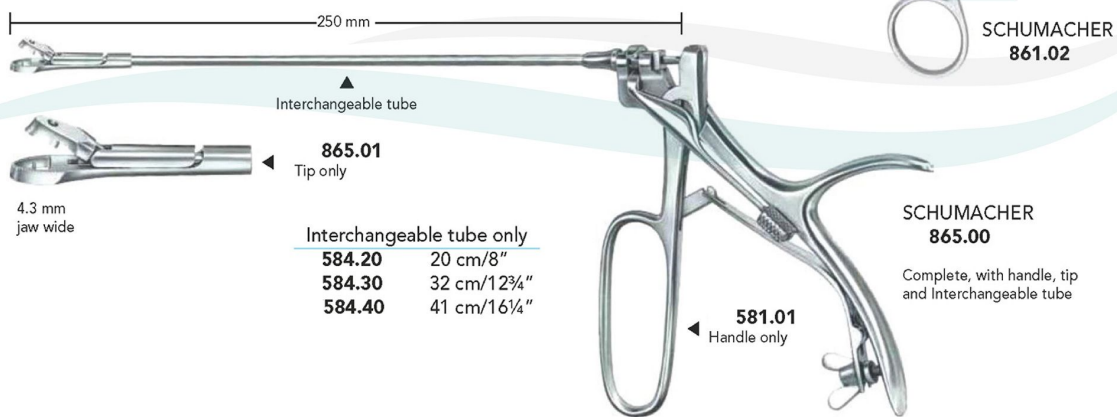
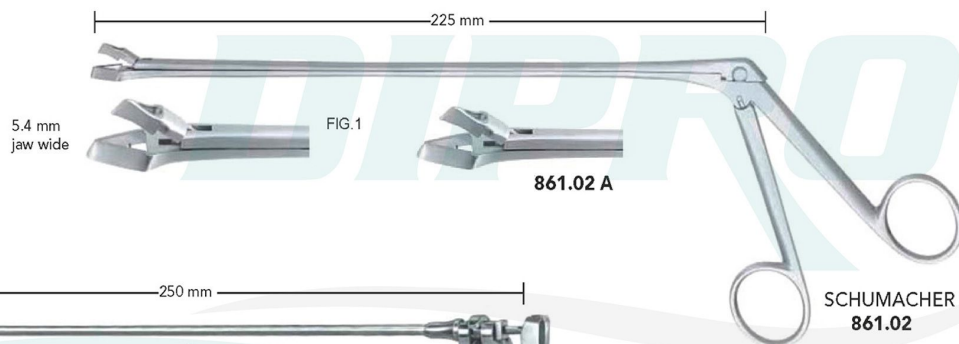
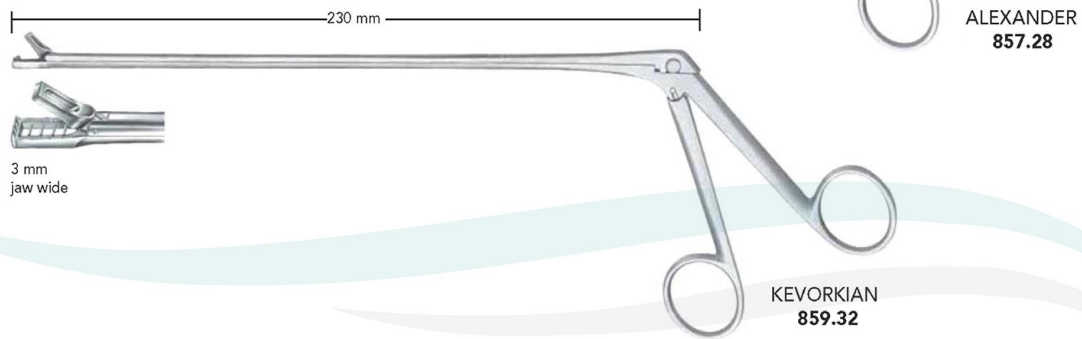
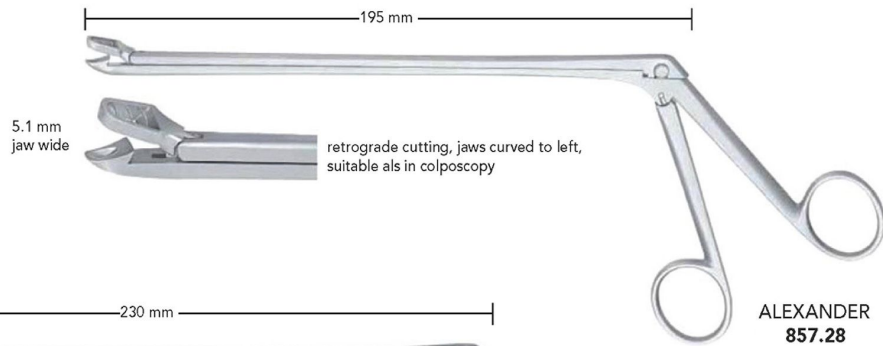

Interchangeable tube only	
<b>584.20</b>	20 cm/8"
<b>584.30</b>	32 cm/12¾"
<b>584.40</b>	41 cm/16¼"

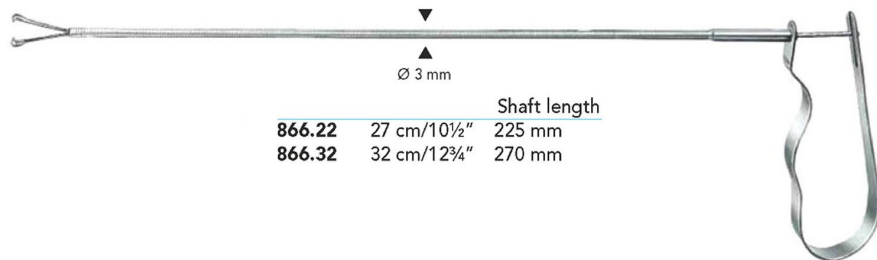



**Gynecology (Uterine Scoops, Uterine Curettes)**

Suction Curettes

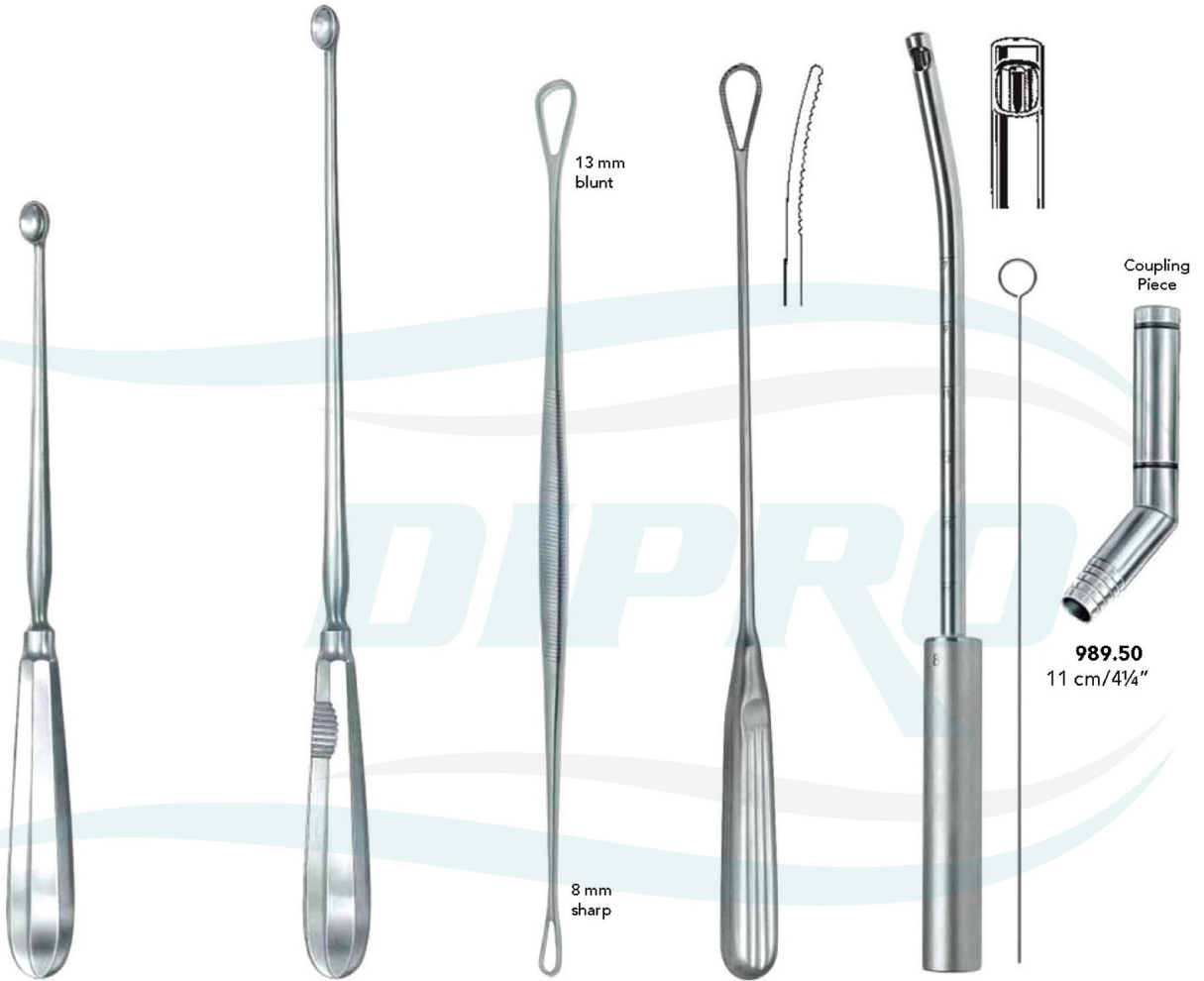

	SIMON 23.5 cm/9¼"		SIMON 24 cm/9½"		BLAKE 919.00 27.5 cm/10¾"	GREENE 28 cm/11"		29 cm/11¼"	
Fig. 1	<b>900.01</b>	10 x 7 mm	<b>906.01</b>	10 x 7 mm		<b>924.10</b>	10 mm	<b>989.03</b>	∅ 3.0 mm
Fig. 2	<b>900.02</b>	12 x 8 mm	<b>906.02</b>	12 x 8 mm		<b>924.12</b>	12 mm	<b>989.04</b>	∅ 4.5 mm
Fig. 3	<b>900.03</b>	13 x 10 mm	<b>906.03</b>	13 x 10 mm		<b>924.14</b>	14 mm	<b>989.06</b>	∅ 6.0 mm
Fig. 4	<b>900.04</b>	16 x 12 mm	<b>906.04</b>	16 x 12 mm				<b>989.08</b>	∅ 8.0 mm
Fig. 5	<b>900.05</b>	18 x 13 mm	<b>906.05</b>	18 x 13 mm				<b>989.10</b>	∅ 10 mm
Fig. 6	<b>900.06</b>	20 x 15 mm	<b>906.06</b>	20 x 15 mm				<b>989.12</b>	∅ 12 mm
								<b>989.14</b>	∅ 14 mm



**Gynecology (Uterine Curettes)**

**RECAMIER**

Fig.	Tip width	Sharp, rigid	Sharp, malleable
00	5 mm	920.05	921.05
0	6 mm	920.06	921.06
1	7 mm	920.07	921.07
2	8 mm	920.08	921.08
3	9 mm	920.09	921.09
4	11 mm	920.11	921.11
5	12 mm	920.12	921.12
6	14 mm	920.14	921.14
7	15 mm	920.15	921.15
8	16 mm	920.16	921.16
9	19 mm	920.19	921.18
10	20 mm	920.20	921.20
11	21 mm	920.21	921.21
12	23 mm	920.23	921.23
13	25 mm	920.25	921.25
14	30 mm	920.30	921.30
15	35 mm	920.35	921.35
16	40 mm	920.40	921.40

sharp, rigid

sharp, malleable

blunt, rigid

blunt, malleable



RECAMIER  
920.05-  
920.40



RECAMIER  
921.05-  
921.40



SIMS  
926.05-  
926.40



SIMS  
927.05-  
927.40

**SIMS**

Fig.	Tip width	Blunt, rigid	Blunt, malleable
00	5 mm	926.05	927.05
0	6 mm	926.06	927.06
1	7 mm	926.07	927.07
2	8 mm	926.08	927.08
3	9 mm	926.09	927.09
4	11 mm	926.11	927.11
5	12 mm	926.12	927.12
6	14 mm	926.14	927.14
7	15 mm	926.15	927.15
8	16 mm	926.16	927.16
9	19 mm	926.19	927.19
10	20 mm	926.20	927.20
11	21 mm	926.21	927.21
12	23 mm	926.23	927.23
13	25 mm	926.25	927.25
14	30 mm	926.30	927.30
15	35 mm	926.35	927.35
16	40 mm	926.40	927.40



**Gynecology (Obstetrical Forceps)**



**NAEGELE**  
36.5 cm/14½" **141.36**  
40.5 cm/16¼" **141.40**



**SIMPSON**  
**145.30**  
30.5 cm/12"



**WRIGLEY**  
**146.28**  
28 cm/11"



**SIMPSON**  
**149.36**  
36.5 cm/14¼"



**KIELLAND**  
**195.41**  
41 cm/16½"



**KIELLAND-LUIKART**  
**197.40**  
40 cm/16"



**PIPER**  
**198.44**  
44.5 cm/17¾"



Pelvimeter

**103.34**  
35 cm/14"



Obstetrical Lever

**SELLHEIM**  
**309.28**  
32 cm/12¾"

Umbilical Clamps



**COLLIN**  
**465.09**  
8.5 cm/3½"



**Gynecology (Placenta & Ovum Forceps, Placenta Scoops)**



blunt, backside serrated

**CUZZI**  
30 cm/12" **382.01**  
30 cm/12" **382.02**  
30 cm/12" **382.03**

**PESTALOZZA**  
**386.30**  
30.5 cm/12"

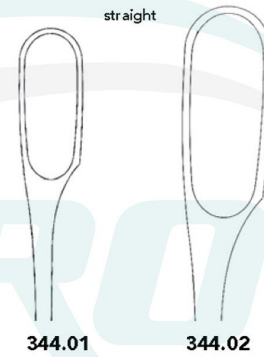

straight

**344.01**

**344.02**

Uterine Clamp



**GREEN-ARMYTAGE**  
**300.21**  
21 cm/8¼"

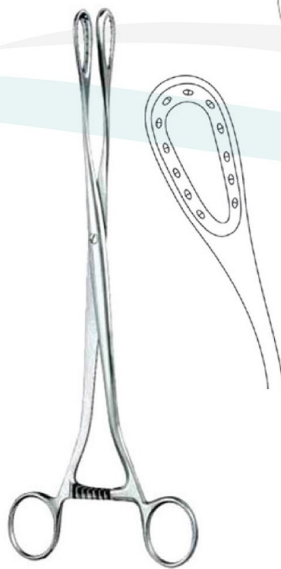

**SAENGER**  
27.5 cm/10¾"  
**228.27** Straight  
**229.27** Curved



**WINTER**  
28 cm/11"

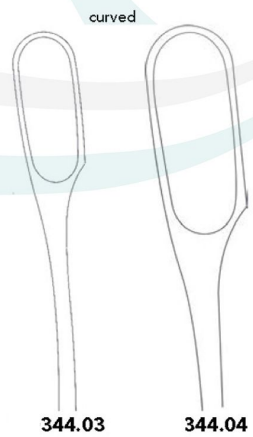

curved

**344.03**

**344.04**