

- EN Finishing Instruments
- DE Finierinstrumente
- ES Instrumentos para acabar orificaciones



DIPRO



64

Filling Instruments

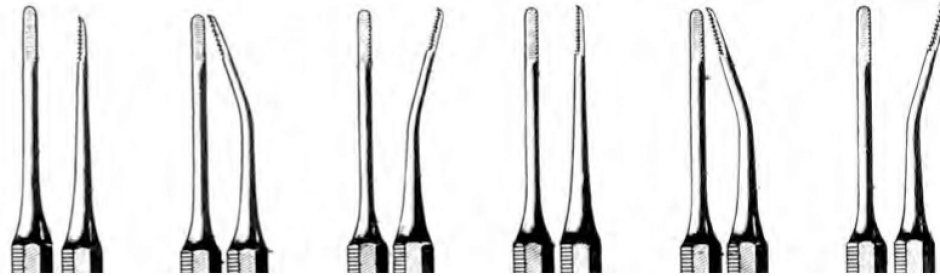

WEDELSTAEDT

64.120.01 Fig. 1 64.120.02 Fig. 2 64.120.03 Fig. 3 64.120.04 Fig. 4 64.120.05 Fig. 5 64.120.06 Fig. 6

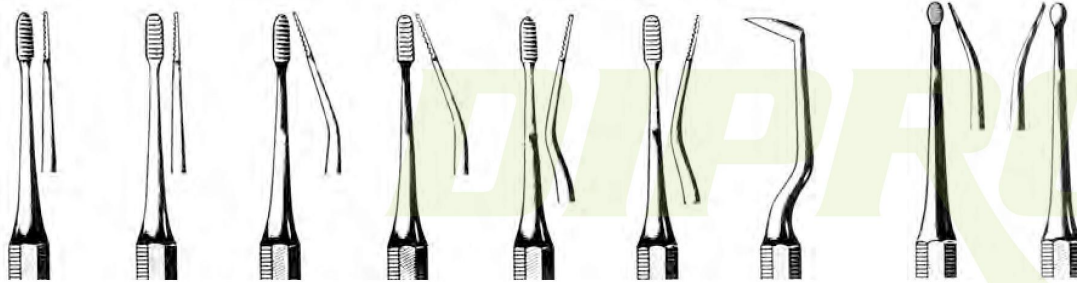

BLACK

RHEIN

64.123.01 Fig. 1 64.123.02 Fig. 2 64.123.03 Fig. 3 64.123.04 Fig. 4 64.123.05 Fig. 5 64.123.06 Fig. 6 64.123.08 Fig. 8 64.126.31 Fig. 31 64.126.32 Fig. 32

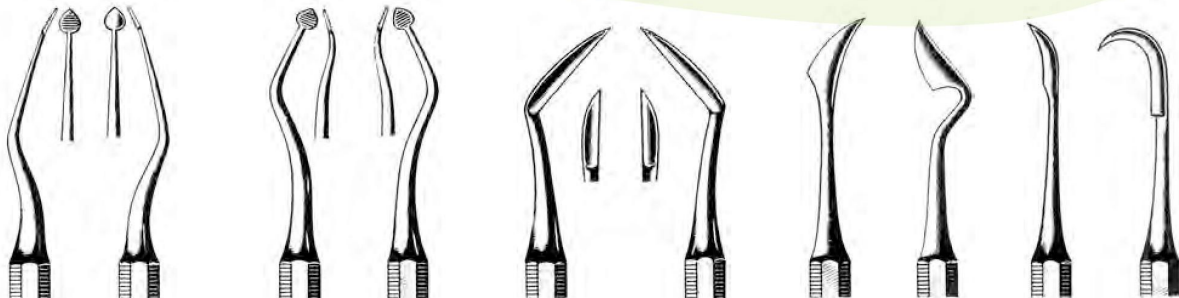

TOMPKINS

PICHLER

64.129.01 Fig. 1 64.129.02 Fig. 2 64.129.03 Fig. 3 64.129.04 Fig. 4 64.131.01 Fig. 1 64.131.02 Fig. 2 64.131.03 Fig. 3 64.131.04 Fig. 4 64.133.01 Fig. 1 64.133.02 Fig. 2 64.135.01 Fig. 3 64.135.02 Fig. 4

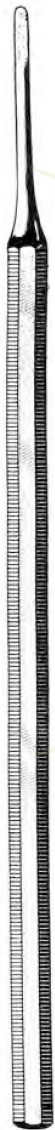

- EN Amalgam plugger, Condenser
- DE Amalgam Stopfer
- ES Obturadores para amalgama



MODELL AMALGAM

64.151.10	64.151.20	64.151.30	64.151.40	64.151.50	64.151.51	64.151.60	64.151.70
Fig. 1	Fig. 2	Fig. 3	Fig. 4	Fig. 5	Fig. 5A	Fig. 6	Fig. 7

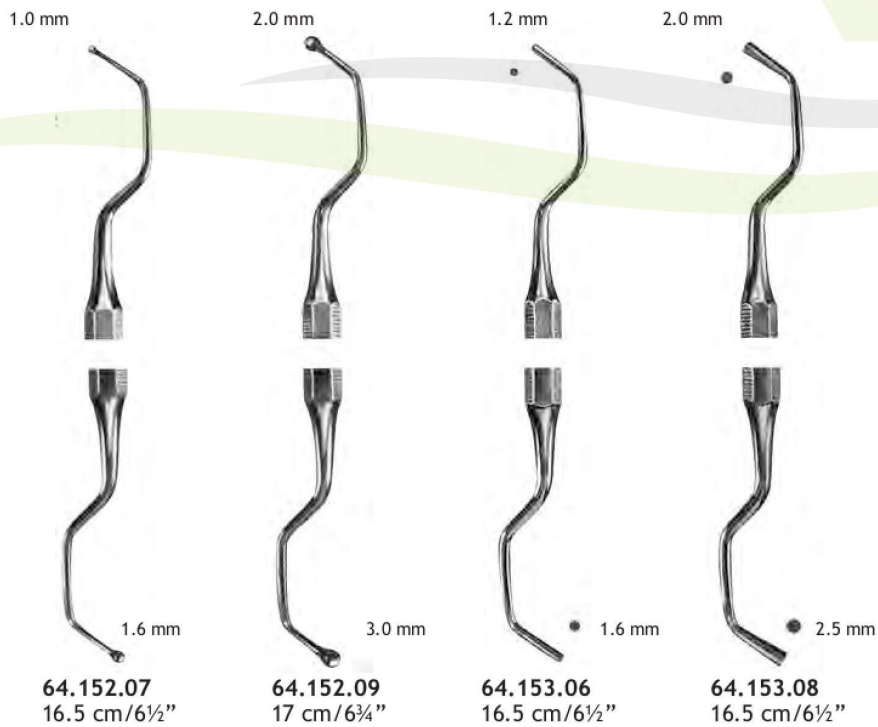

- EN Amalgam plugger, Condenser
- DE Amalgam Stopfer
- ES Obturadores para amalgama



HOLLENBACK							MOD. USA	
64.175.01	64.175.02	64.175.03	64.175.04	64.175.05	64.175.06	64.175.07	64.177.01	64.177.02
64.175.01R	64.175.02R	64.175.03R	64.175.04R	64.175.05R	64.175.06R	64.175.07R	Fig. 1/21	Fig. 2/21B
Fig. 1	Fig. 2	Fig. 3	Fig. 4	Fig. 5	Fig. 6	Fig. 7		

EN Amalgam Carriers
 DE Amalgam- Träger
 ES Porta-amalgamas

Amalgam Finger bowl
 Amalgam-Fingerbecher
 Vaso para dedos de amalgama



64.200.31
 Ø 30 mm

bottom rund
 Boden rund
 basa redonda

64.201.30
 Ø 30 mm

bottom flat
 Boden flach
 basa plana



IVORY
 64.206.17
 17 cm/3¼"

IVORY
 64.206.21
 21 cm/8¼"

EN Brunishers
 DE Polierinstrumente
 ES Bruñidores

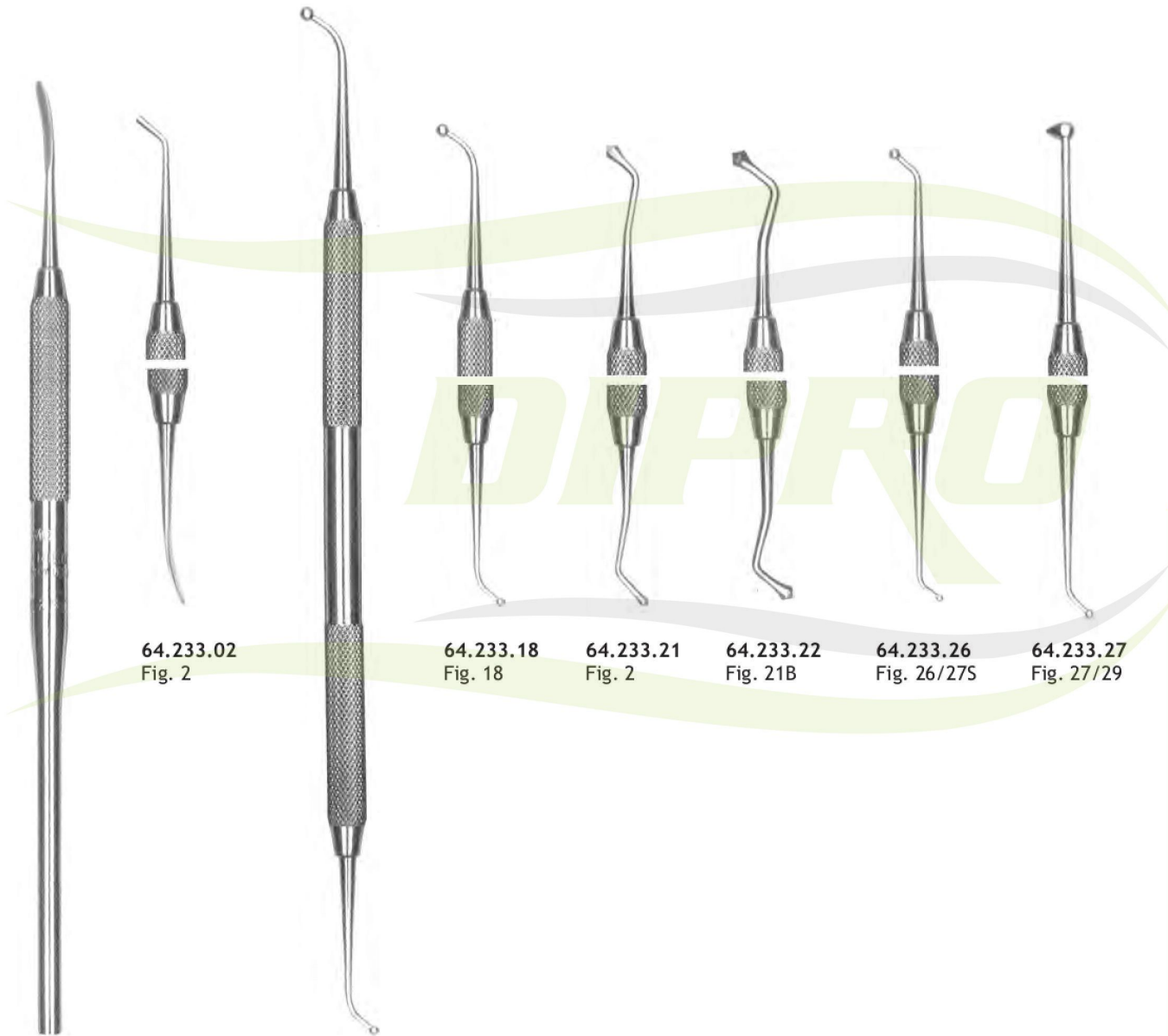

64.233.02
 Fig. 2

64.233.18
 Fig. 18

64.233.21
 Fig. 2

64.233.22
 Fig. 21B

64.233.26
 Fig. 26/27S

64.233.27
 Fig. 27/29

64.233.01
 Fig. 2

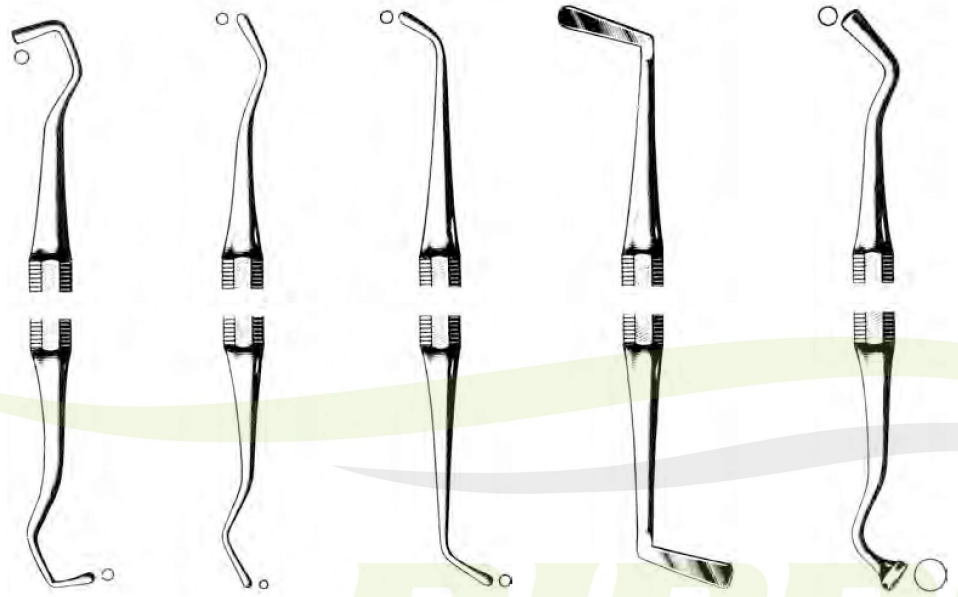

LADMORE

64.261.01
Fig. 1

64.261.02
Fig. 2

64.261.03
Fig. 3

64.261.04
Fig. 4

64.261.05
Fig. 5

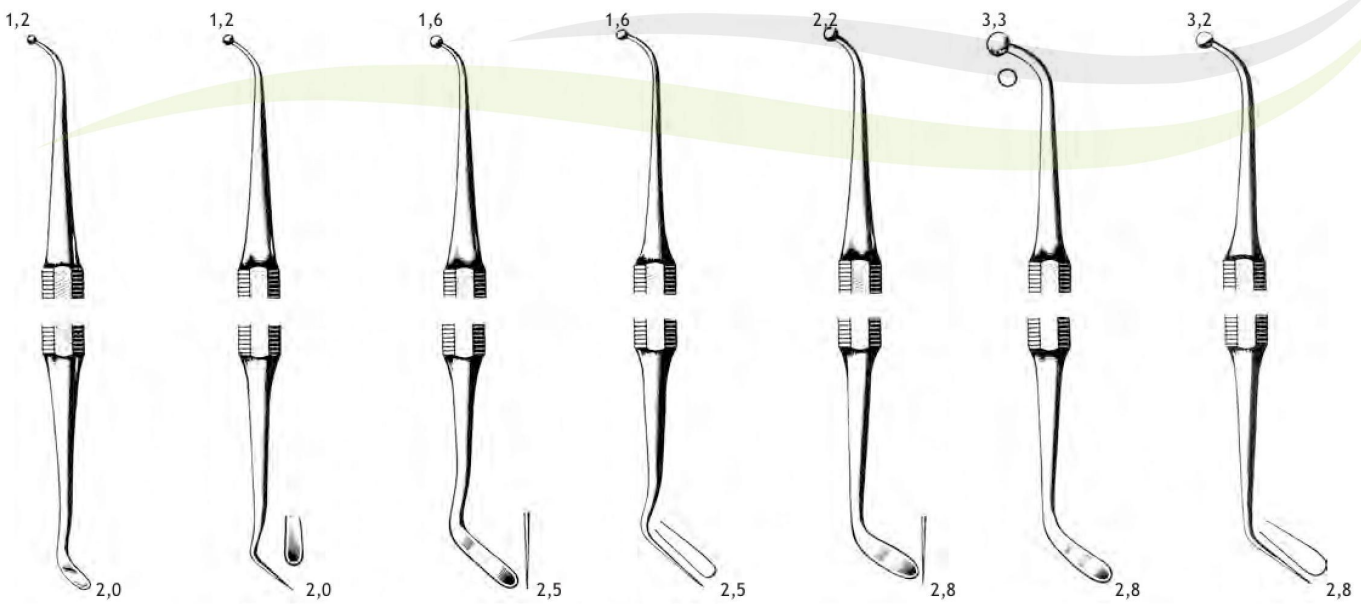

64.270.10
Fig. 1

64.270.20
Fig. 2

64.270.30
Fig. 3

64.270.31
Fig. 3A

64.270.40
Fig. 4

64.270.41
Fig. 4A

64.270.42
Fig. 4B

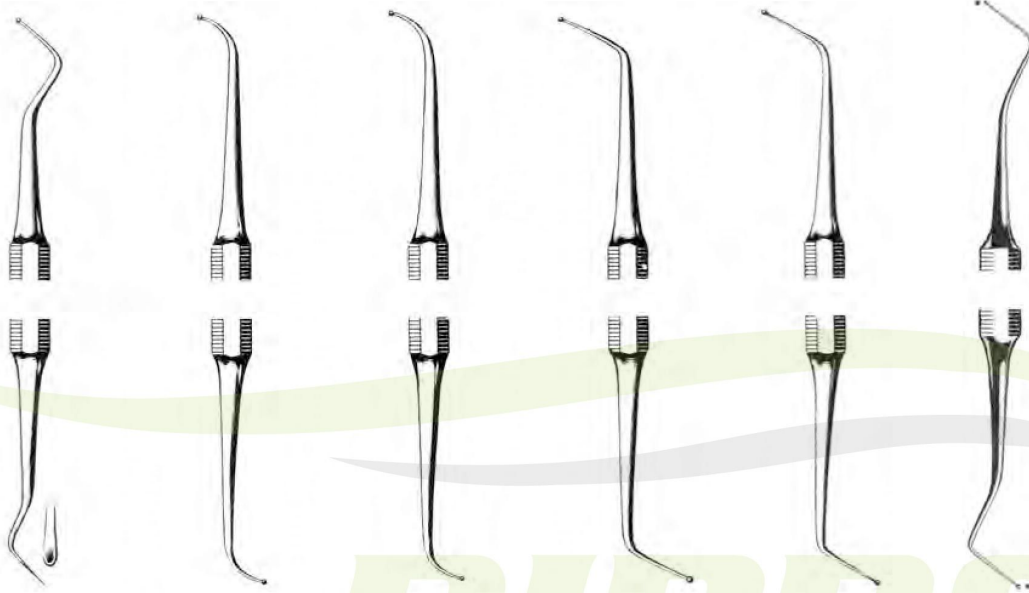

64.271.15
Fig. 15

64.271.16
Fig. 16

64.271.17
Fig. 17

64.271.18
Fig. 18

64.271.19
Fig. 19

DYCAL
64.271.20
Fig. 20



HEIDEMANN
 64.277.00 64.277.01 64.277.02
 64.277.00R 64.277.01R 64.277.02R
 Fig. 0 Fig. 1 Fig. 2

MOESLE
 64.278.01 64.278.02
 Fig. 1 Fig. 2

MESSER
 64.280.01 64.280.02 64.280.03
 Fig. 1 Fig. 2 Fig. 3



WHITE

64.301.03 Fig. 3 64.301.04 Fig. 4 64.301.10 Fig. 1 64.301.20 Fig. 2 64.301.30 Fig. 3 64.301.40 Fig. 4 64.301.50 Fig. 5 64.301.51 Fig. 5A 64.301.60 Fig. 6



WHITE

WOODSON

CLEVELAND

64.305.10 Fig. 10 64.305.21 Fig. 21 64.305.30 Fig. 30 64.305.50 Fig. 50 64.305.51 Fig. 5A 64.305.60 Fig. 60 64.311.01 Fig. 1 64.311.02 Fig. 2 64.311.03 Fig. 3 64.315.05 Fig. 5

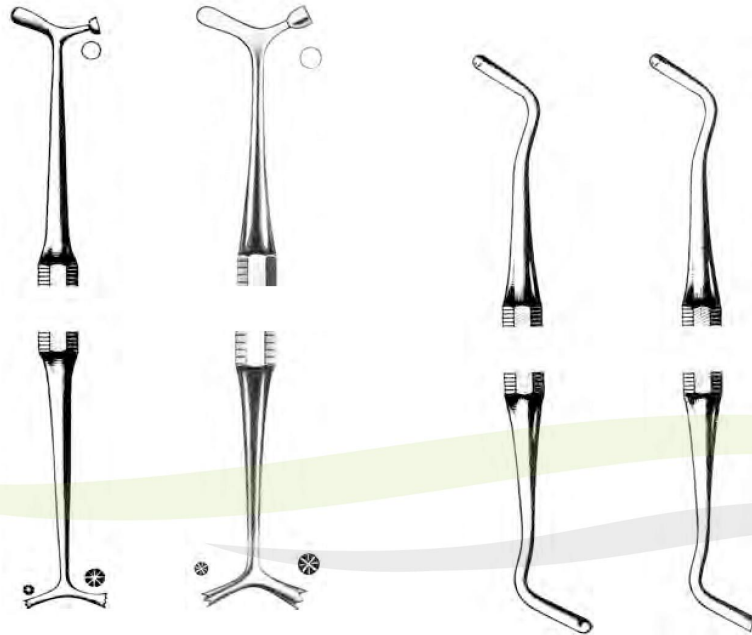

BENNET
 64.349.07 Fig. 7 64.349.10 Fig. 10 64.351.01 Fig. 1 64.351.02 Fig. 2

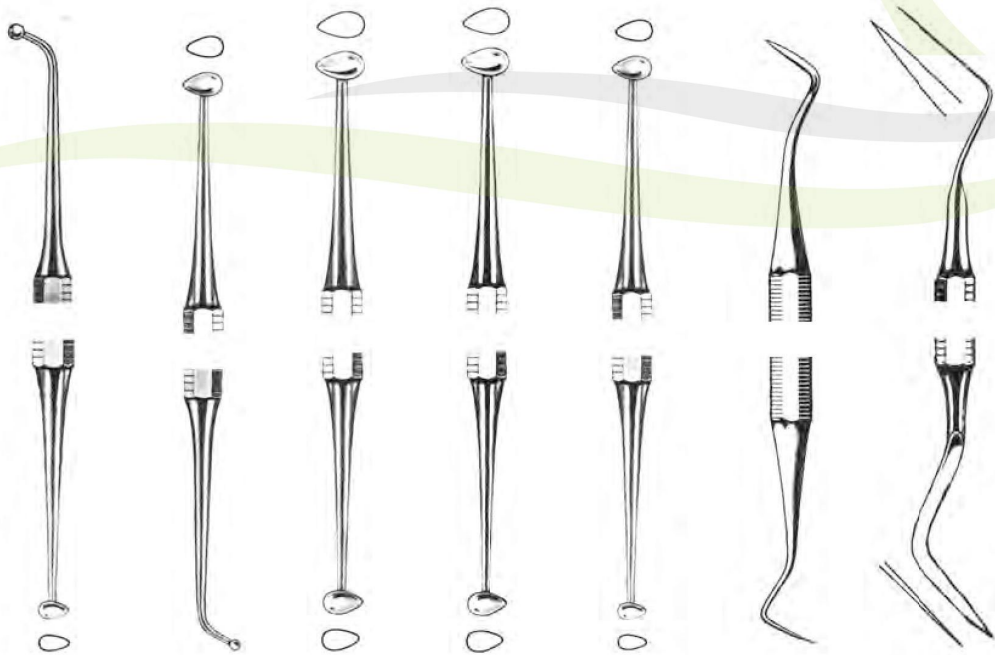

64.357.25 Fig. 25/31 64.357.26 Fig. 26/29 64.357.27 Fig. 27/29 64.357.28 Fig. 28/29 64.357.29 Fig. 29/31 64.358.00 BRUDER 64.359.00

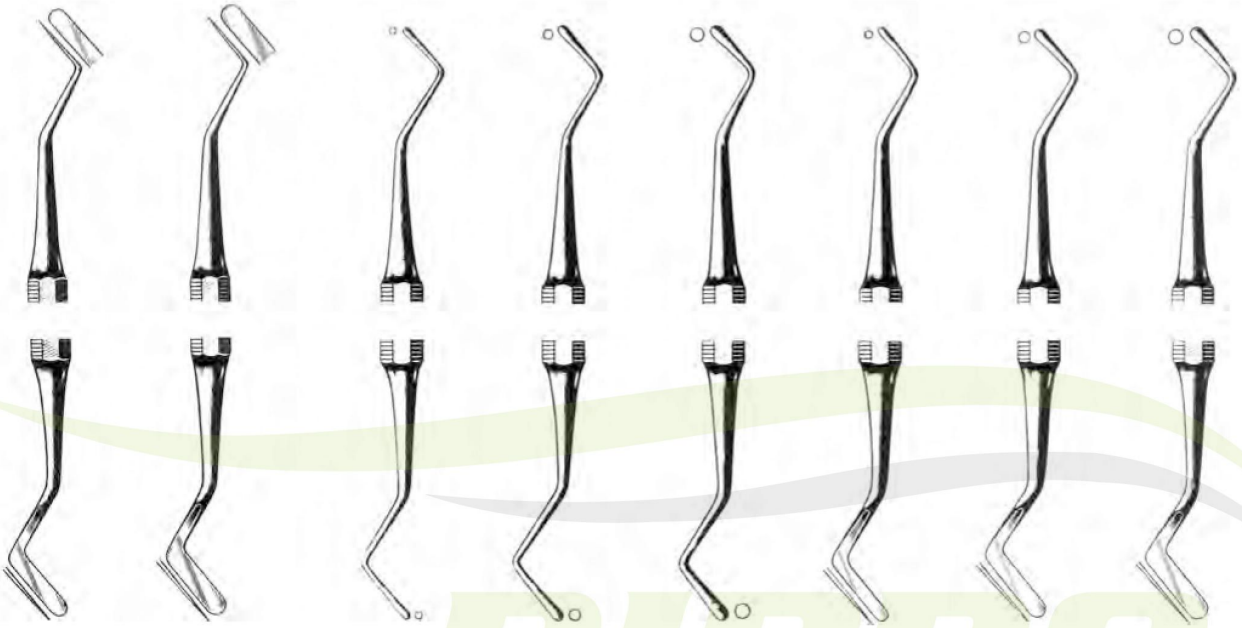

64.361.15 Fig. 15 64.361.16 Fig. 16 64.361.17 Fig. 17 64.361.18 Fig. 18 64.361.19 Fig. 19 64.361.20 Fig. 20 64.361.21 Fig. 21 64.361.22 Fig. 22



64.361.23 Fig. 23 64.361.24 Fig. 24 64.361.25 Fig. 25 64.361.26 Fig. 26 64.361.27 Fig. 27 64.361.28 Fig. 28 64.361.29 Fig. 29 64.361.30 Fig. 30

EN Plastic Filling Instruments
 DE Instrumente für plastische füllungen
 ES Instrumentos para obturaciones plásticas

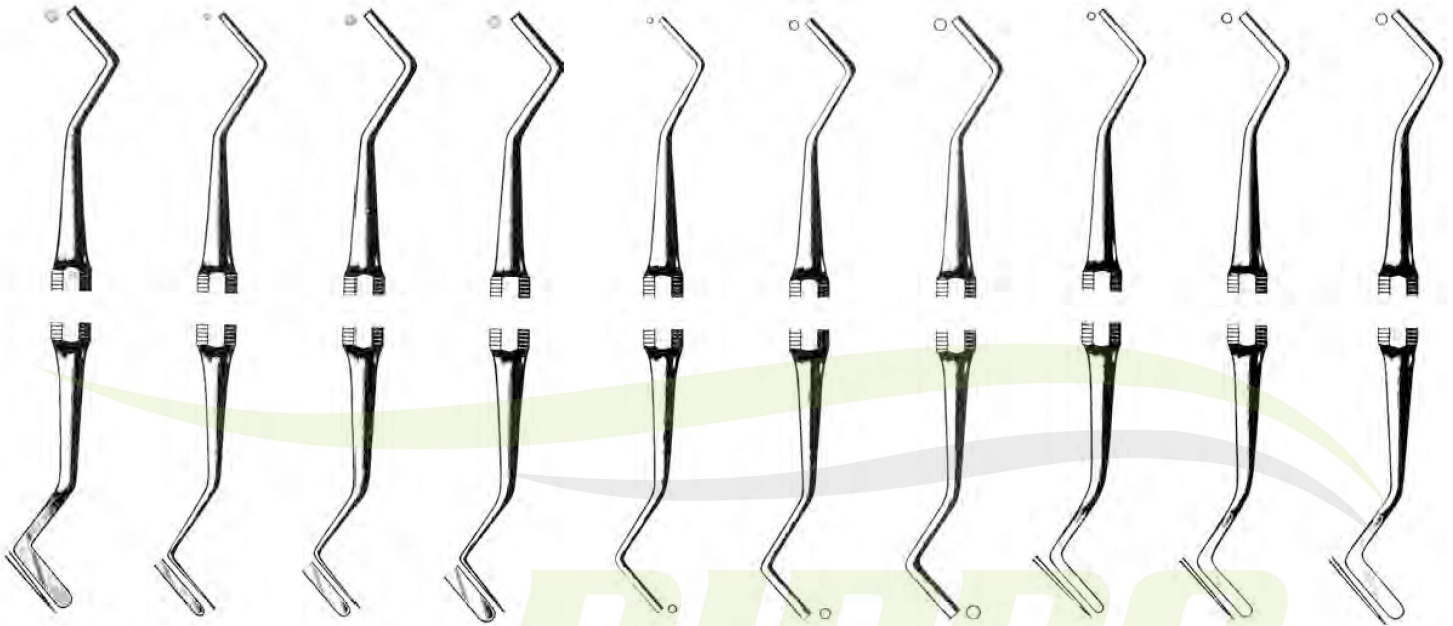

64.361.31 Fig. 31 64.361.32 Fig. 32 64.361.33 Fig. 33 64.361.34 Fig. 34 64.361.35 Fig. 35 64.361.36 Fig. 36 64.361.37 Fig. 37 64.361.38 Fig. 38 64.361.39 Fig. 39 64.361.40 Fig. 40

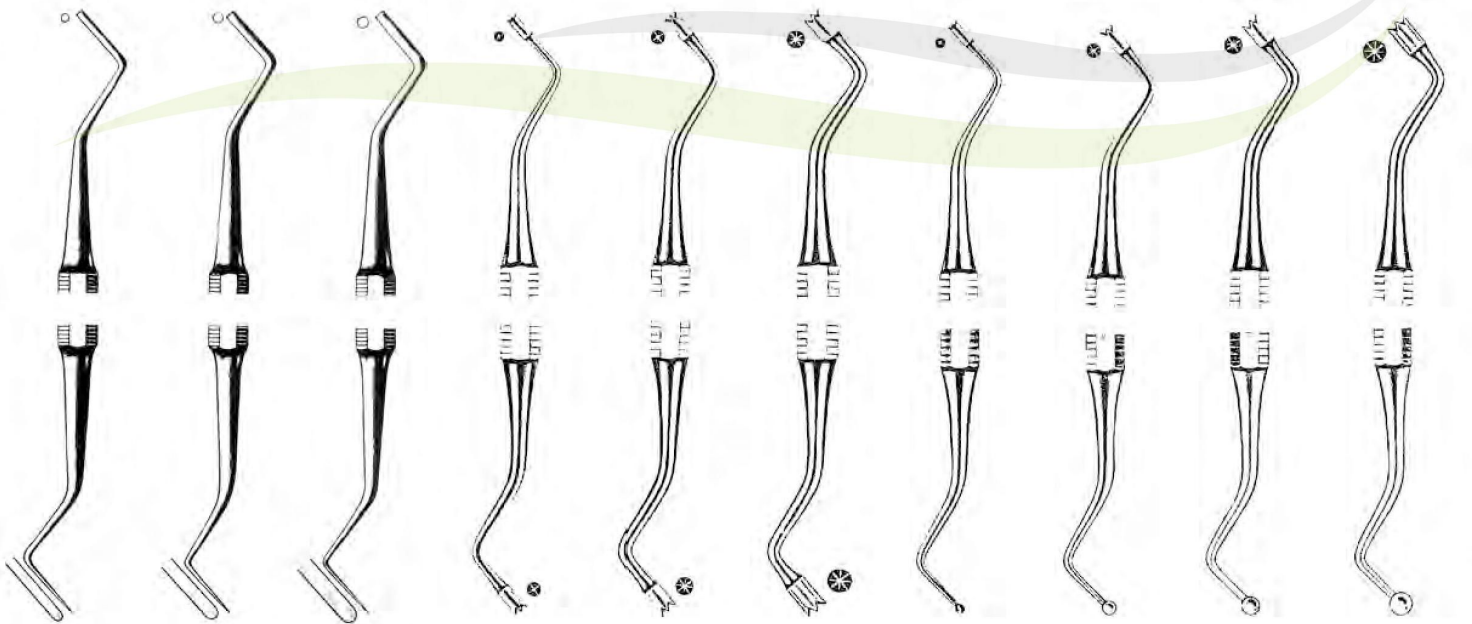

64.361.41 Fig. 41 64.361.42 Fig. 42 64.361.43 Fig. 43 64.361.44 Fig. 44 64.361.45 Fig. 45 64.361.46 Fig. 46 64.361.47 Fig. 47 64.361.48 Fig. 48 64.361.49 Fig. 49 64.361.50 Fig. 50

EN Extracting Forceps for Children, English Pattern
 DE KinderZahnzangen, Englische Form
 ES Forceps Para Nino's, Forma Inglesa

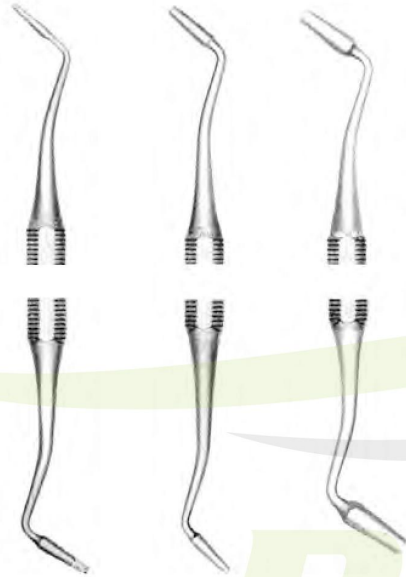

64.371.01
Fig. 1

64.371.02
Fig. 2

64.371.03
Fig. 3

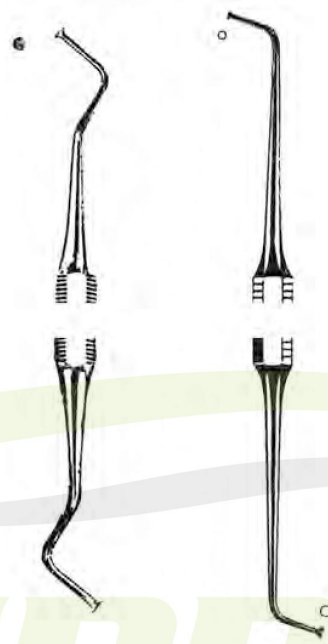

BUECHS
64.385.00
Fig. 2

JOERGENSEN
64.387.00
Fig. 3

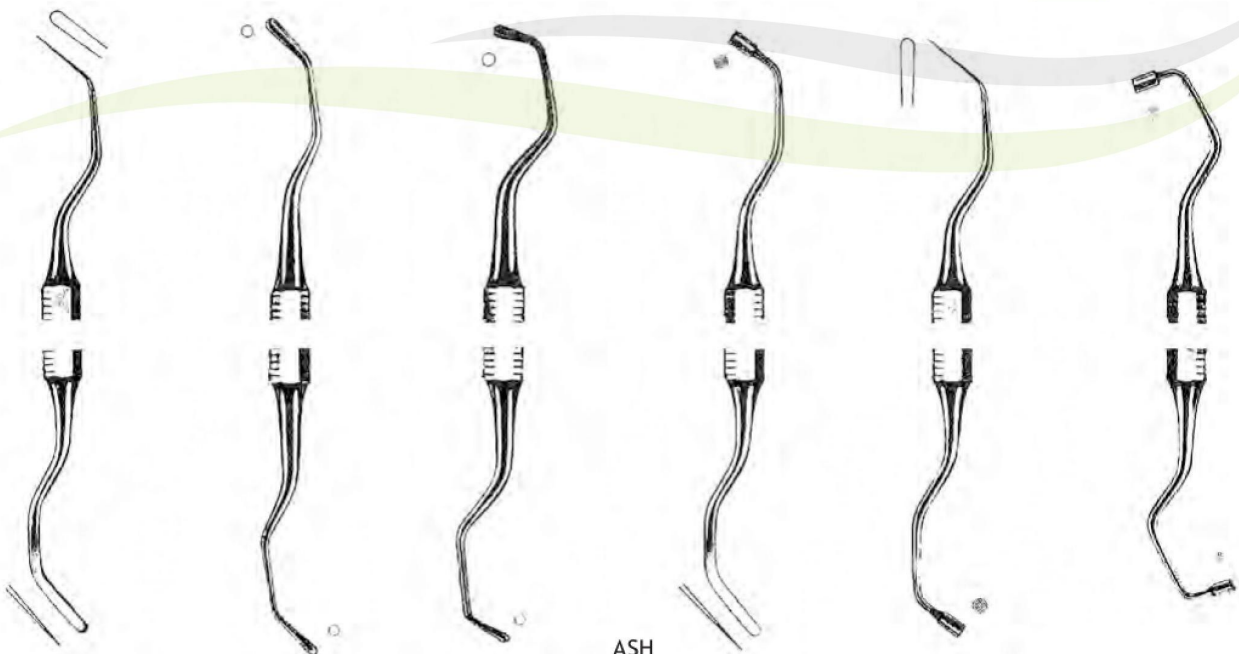

64.381.81
Fig. 181

64.381.82
Fig. 182

64.381.83
Fig. 183

ASH

64.382.01
Fig. M

64.382.02
Fig. N

64.382.03
Fig. O

EN Plastic Filling Instruments
 DE Instrumente für plastische füllungen
 ES Instrumentos para obturaciones plásticas

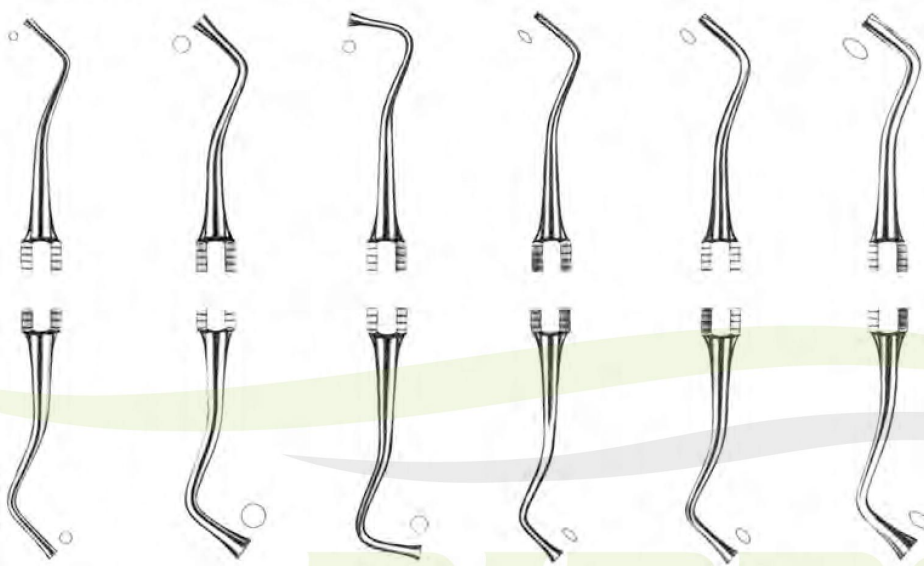

WARD

64.391.01 Fig. 1	64.391.02 Fig. 2	64.391.03 Fig. 3	64.391.04 Fig. 4	64.391.05 Fig. 5	64.391.06 Fig. 6
---------------------	---------------------	---------------------	---------------------	---------------------	---------------------

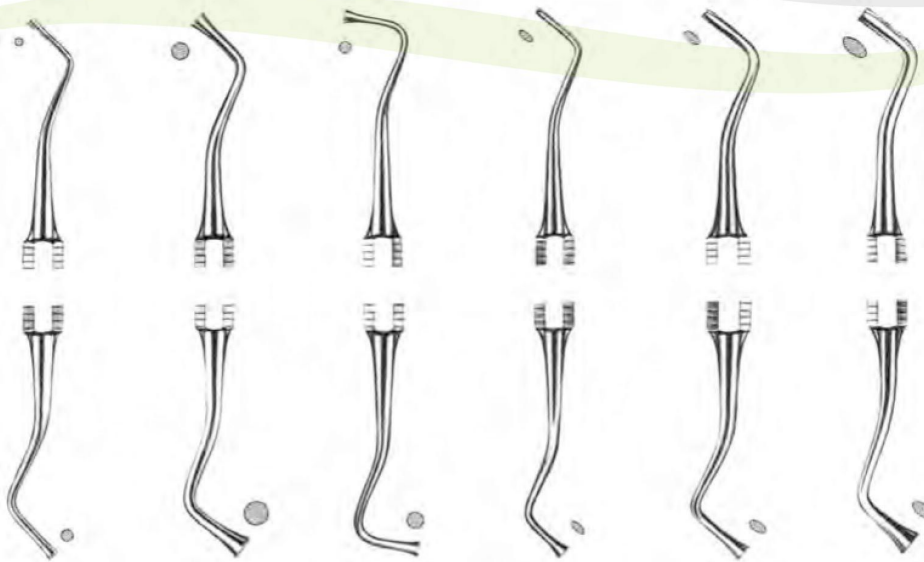

WARD

64.393.01 Fig. 1	64.393.02 Fig. 2	64.393.03 Fig. 3	64.393.04 Fig. 4	64.393.05 Fig. 5	64.393.06 Fig. 6
---------------------	---------------------	---------------------	---------------------	---------------------	---------------------

EN Gutta - percha and cement spatulas
 DE Guttapercha - und Zementspatel
 ES Espátulas para gutapercha y cemento

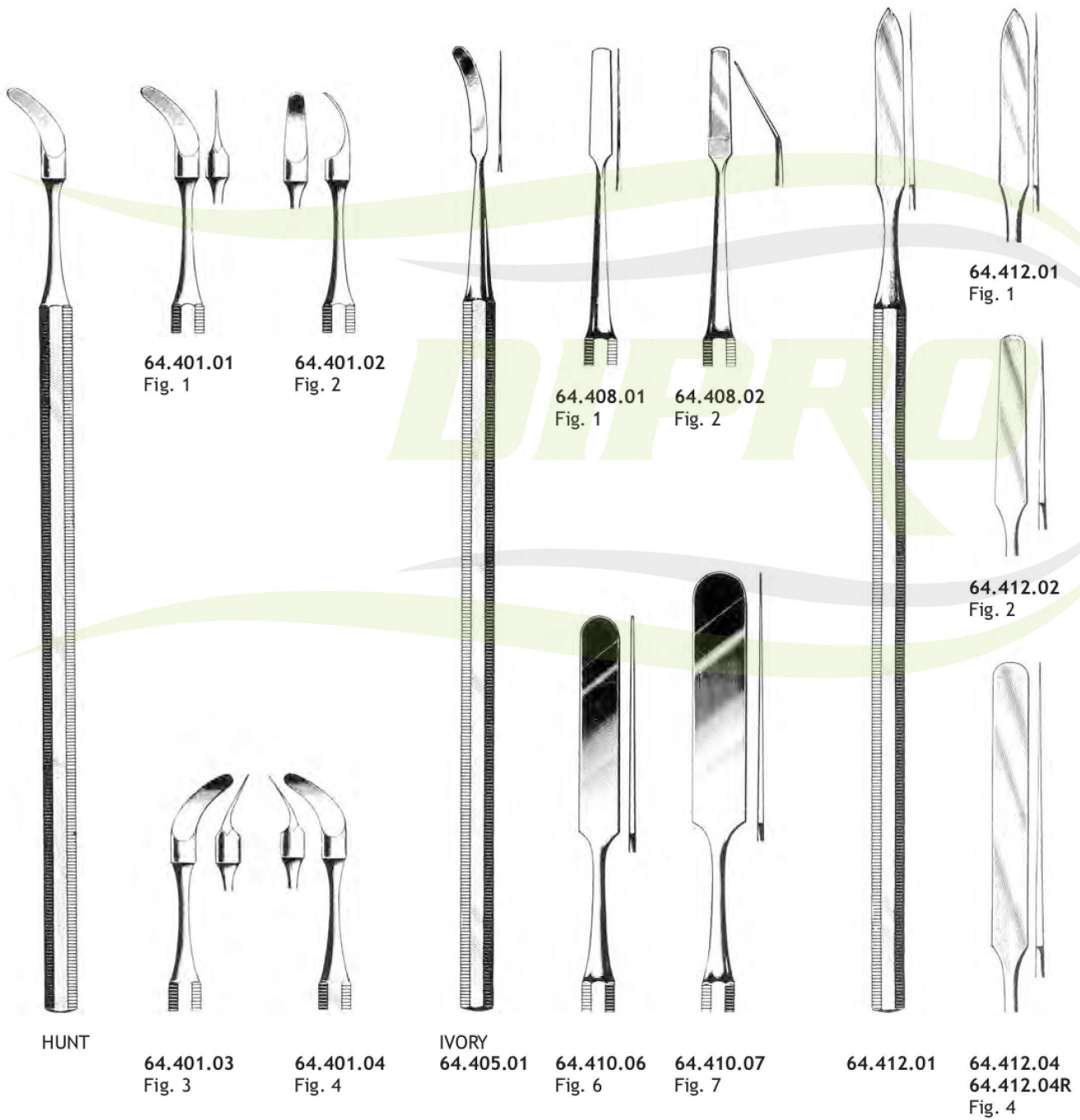

Filling Instruments

HUNT

IVORY

64

EN Cement Spatulas
 DE Zement-Spatel
 ES Espátulas para cemento

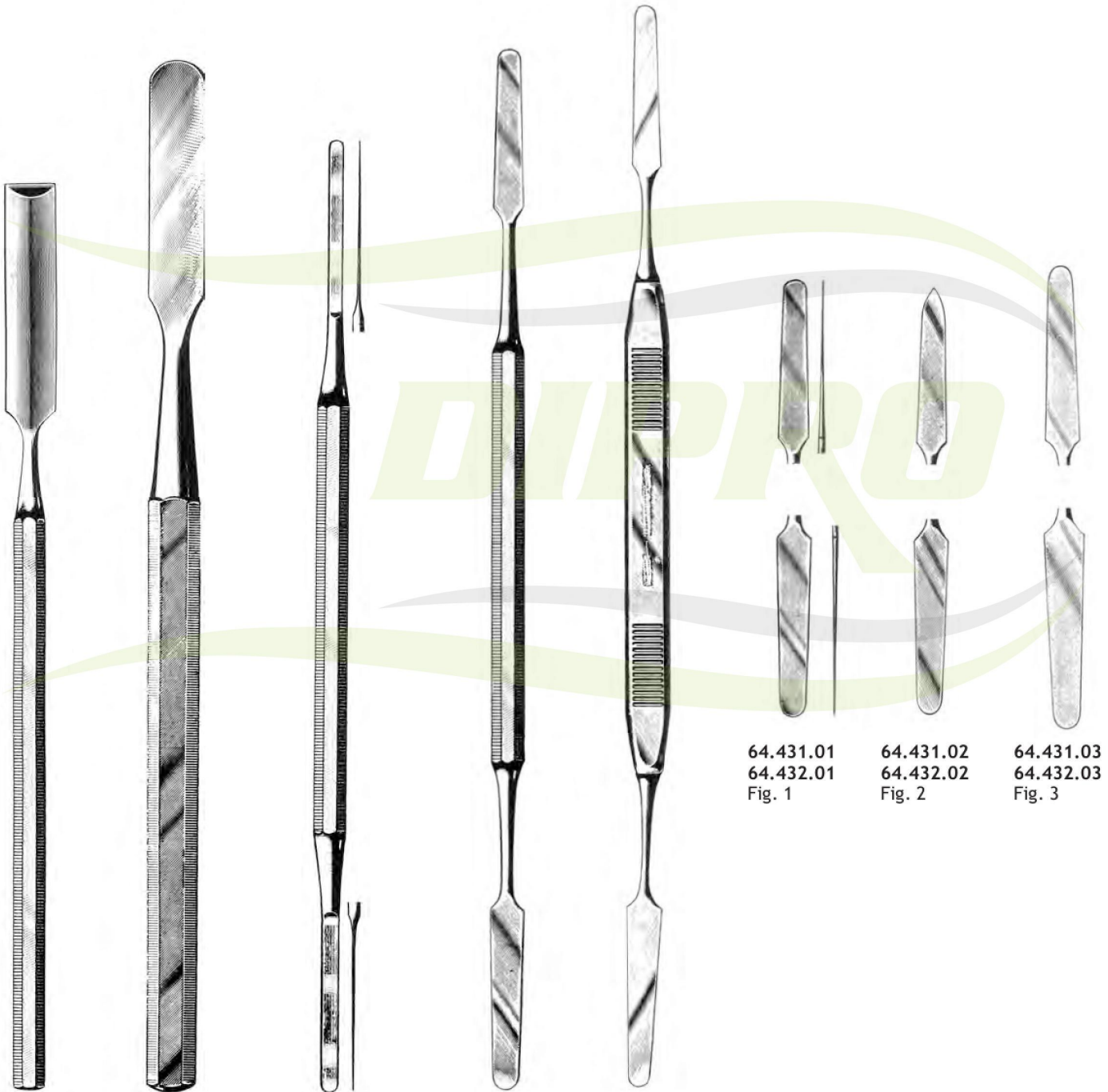

64.416.01

64.420.36
 64.420.36R
 Fig. 36

64.426.01
 64.426.01R
 Fig. 1

64.431.01
 64.431.02
 Fig. 1

64.432.01
 64.432.02
 Fig. 2

64.431.01
 64.432.01
 Fig. 1

64.431.02
 64.432.02
 Fig. 2

64.431.03
 64.432.03
 Fig. 3

EN Cement Spatulas - Silicate Spatulas
 DE Zement-Spatel - silikatspatel
 ES Espátulas para cemento y silicato

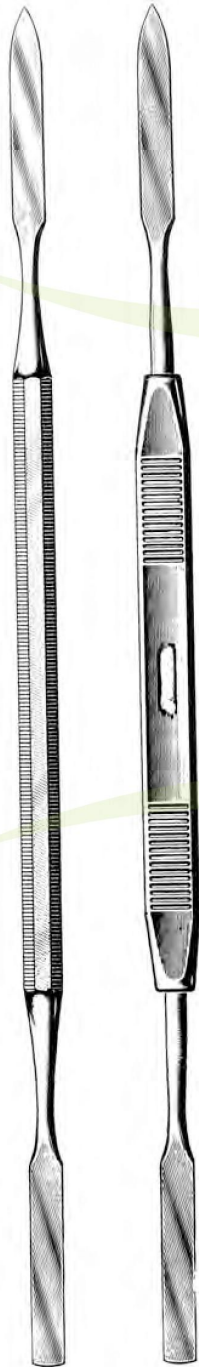

A B
 CESPA
 MOD. MARTIN

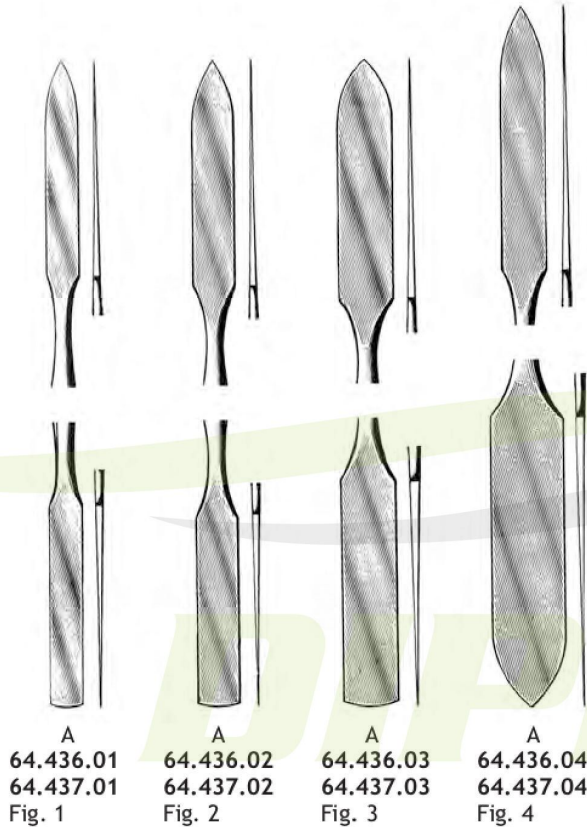

A
 64.436.01
 64.437.01
 Fig. 1

A
 64.436.02
 64.437.02
 Fig. 2

A
 64.436.03
 64.437.03
 Fig. 3

A
 64.436.04
 64.437.04
 Fig. 4

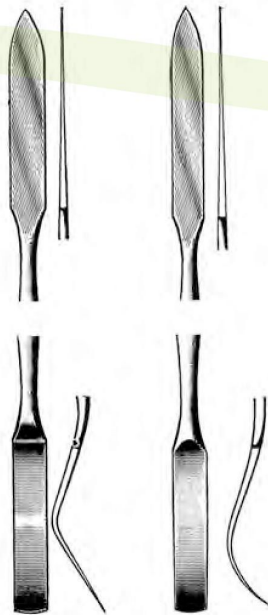

64.436.05
 64.437.05
 Fig. 5

64.436.06
 64.437.06
 Fig. 6

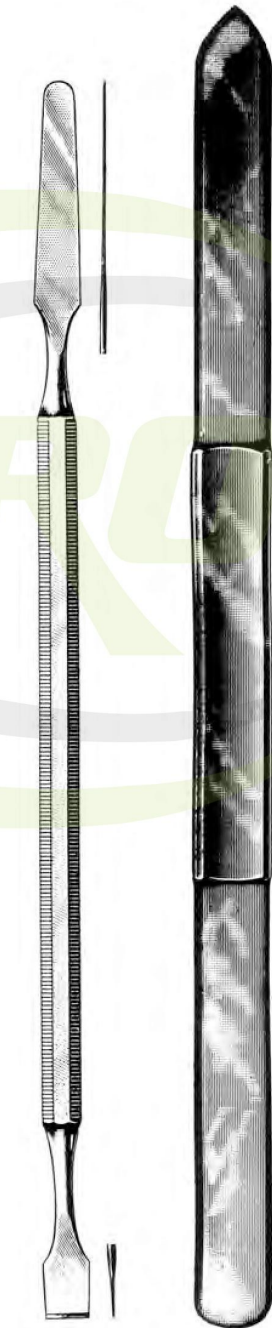

WESTON
 64.450.01

64.455.01

- EN Matrix band and retainers
- DE Matrizen und Matrizenspanner
- ES Portamatrices y matrices



IVORY
64.460.01



IVORY
64.465.01



IVORY
64.467.01



IVORY
64.468.01

EN Matrix band and retainers
 DE Matrizen und Matrizenspanner
 ES Portamatrices y matrices

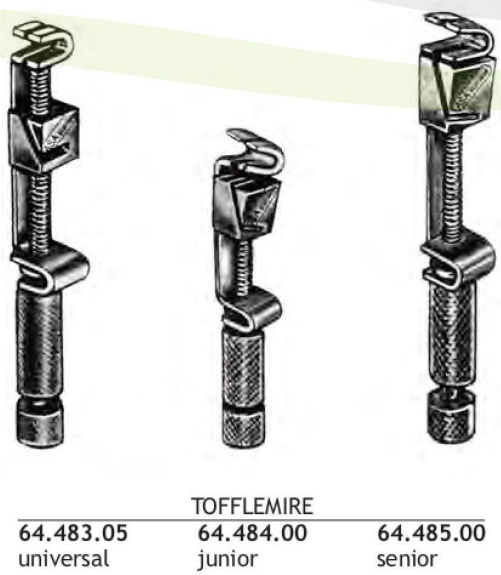
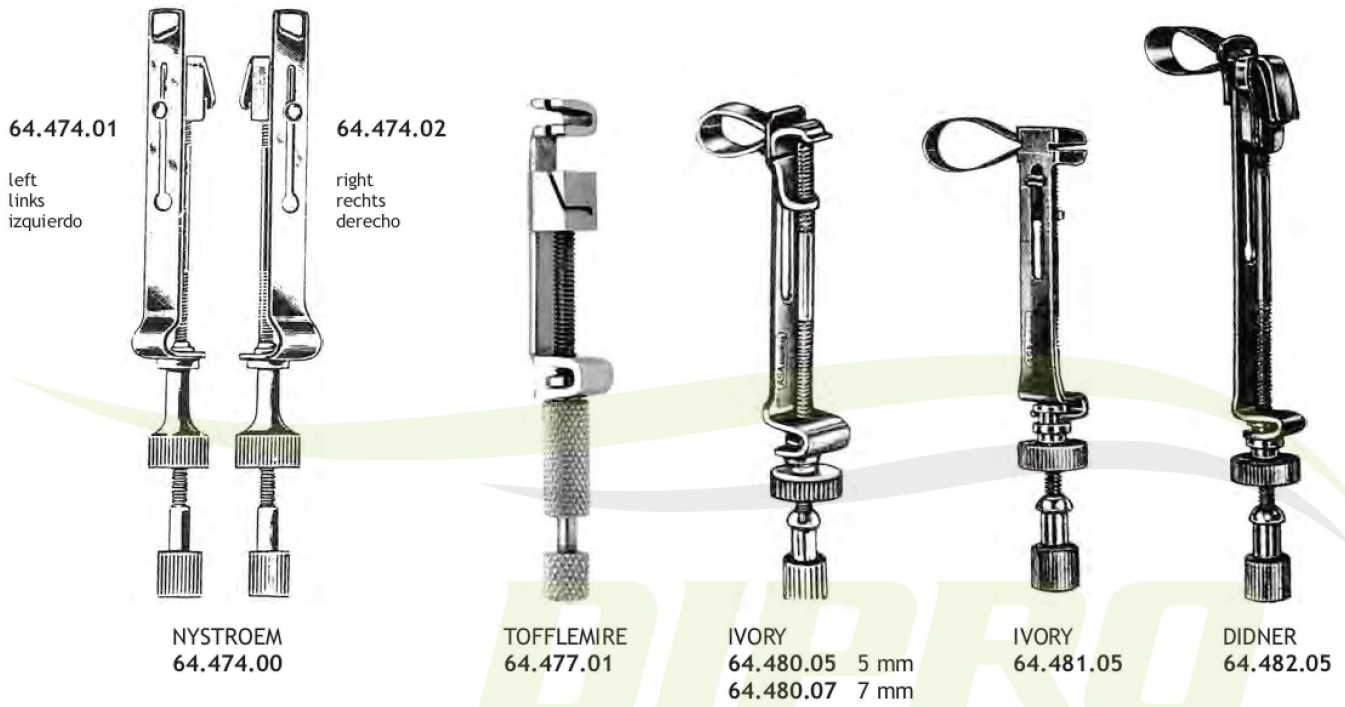

Filling Instruments

64

EN Clamp Forceps
DE portaclampes
ES clamps para dique

DIPRO **DIPROMED**
INSTRUMENTS



TUTTLE
64.490.15
15 cm/6"



AINSWORTH
64.500.16
16 cm/6¼"



IVORY
64.502.17
17 cm/6¾"

DIPRO

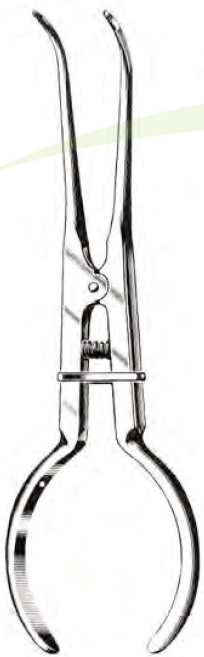

17 cm/6¾"



STOCKES
64.503.17



PALMER
64.505.17



IVORY
64.514.17
17 cm/6¾"

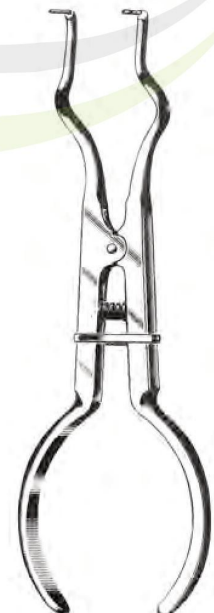

BREWER
64.513.17
17 cm/6¾"

EN Clamp Forceps
DE portaclampes
ES clamps para dique

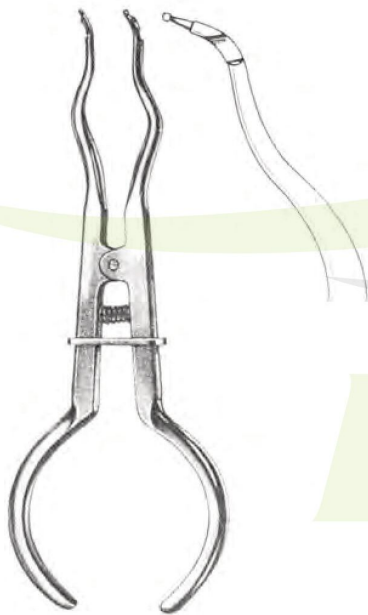

IVORY
64.525.17
17.5 cm/7"



64.530.17
17.5 cm/7"



BAADE
64.600.00



Rubber dam frame
 Kofferdam-Rahmen

64.514.00 110 x 95 cm
 64.514.01 110 x 110 cm



IVORY

64.515.26 Fig. 26 64.515.27 Fig. 27 64.515.28 Fig. 28 64.515.29 Fig. 29 64.515.30 Fig. 30 64.515.31 Fig. 31 64.515.51 Fig. 51 64.515.60 Fig. 60



IVORY

64.518.200 64.518.201 64.518.202 64.518.203 64.518.204 64.518.205

EN Rubber Dam Instruments
 DE Kofferdam-Instrumente
 ES Dique de goma



64.518.30



64.518.31



IVORY
 64.518.51



64.518.138



64.518.139



64.518.15



64.518.18



64.518.24

IVORY



64.518.25



64.518.26



64.518.28



64.518.206



64.518.207



64.518.208

IVORY



64.518.209



64.518.22



IVORY
 64.518.27



64.518.29



64.518.210



IVORY
 64.518.211



64.518.212

64

EN Crown Slitter
DE Kronenaufschneidezange
ES Pinza para cortar coronas

DIPRO **DIPROMED**
INSTRUMENTS



64.600.16