

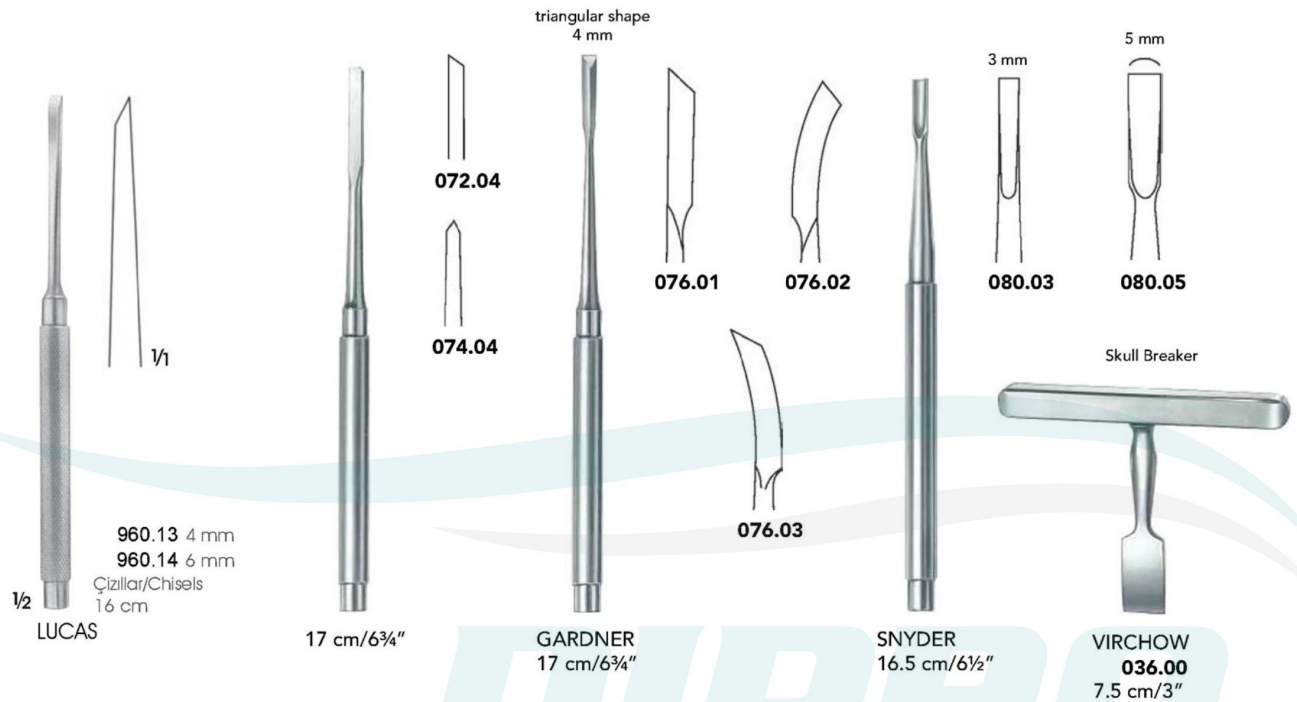

Bone Surgery (Bone Chisels, Gouges, Osteotomes)



	13.5 cm/5 1/4"			13.5 cm/5 1/4"		17 cm/6 3/4"	13.5 cm/5 1/4"		16.5 cm/6 1/2"
8 mm	100.08	101.08	102.08	2 mm	105.02	106.02	109.02	110.02	
10 mm	100.10	101.10	102.10	3 mm	105.03	106.03	109.03	110.03	
12 mm	100.12	101.12	102.12	4 mm	105.04	106.04	109.04	110.04	
14 mm	100.14	101.14	102.14	5 mm	105.05	106.05	109.05	110.05	
16 mm	100.16	101.16	102.16	6 mm	105.06	106.06	109.06	110.06	



Bone Surgery (Bone Chisels, Gouges, Osteotomes)



ALEXANDER
17.5 cm/7"

4 mm	118.04	119.04
6 mm	118.06	119.06
8 mm	118.08	119.08
10 mm	118.10	119.10
12 mm	118.12	119.12
14 mm	118.14	119.14

STILLE
20.5 cm

960.48	10 mm
960.49	12 mm
960.50	15 mm
960.51	20 mm
960.52	25 mm

STILLE
20.5 cm/8"

8 mm	124.08			
10 mm	123.10	124.10	125.10	127.10
12 mm	123.12	124.12	125.12	127.12
15 mm	123.15	124.15	125.15	127.15
20 mm	123.20	124.20	125.20	127.20
25 mm	123.25	124.25	125.25	127.25

LAMBOTTE-MINI
12.5 cm/5"

2 mm	136.02
3 mm	136.03
4 mm	136.04
6 mm	136.06
8 mm	136.08
10 mm	136.10
12 mm	136.12
15 mm	136.15

LAMBOTTE-MINI
17.5 cm/7"

3 mm	136.53
4 mm	136.54
6 mm	136.56
8 mm	136.58
10 mm	136.60
12 mm	136.62
15 mm	136.65

LAMBOTTE
24 cm/9½"

4 mm	138.04
6 mm	138.06
8 mm	138.08
10 mm	138.10
13 mm	138.13
15 mm	138.15
18 mm	138.18
20 mm	138.20
25 mm	138.25
30 mm	138.30
38 mm	138.38
44 mm	138.44
50 mm	138.50

LAMBOTTE
24 cm/9½"

4 mm	139.04
6 mm	139.06
8 mm	139.08
10 mm	139.10
13 mm	139.13
15 mm	139.15
18 mm	139.18
20 mm	139.20
25 mm	139.25
30 mm	139.30
38 mm	139.38
44 mm	139.44
50 mm	139.50



Bone Surgery (Bone Chisels, Gouges, Osteotomes)



SMITH-PETERSEN
20.5 cm/8"

6 mm	154.06	155.06
9 mm	154.09	155.09
13 mm	154.13	155.13
16 mm	154.16	155.16
19 mm	154.19	155.19
25 mm	154.25	155.25
32 mm	154.32	155.32



SMITH-PETERSEN
20.5 cm/8"

9 mm	156.09	157.09
14 mm	156.16	157.16
19 mm	156.19	157.19
25 mm	156.25	157.25



HOKE
17 cm/6¾"

3 mm	162.03
5 mm	162.05
6 mm	162.06
8 mm	162.08
9 mm	162.09



HIBBS
24.5 cm/9¾"

6 mm	170.06	172.06	173.06	176.06	177.06
13 mm	170.13	172.13	173.13	176.13	177.13
19 mm	170.19	172.19	173.19	176.19	177.19
25 mm	170.25	172.25	173.25	176.25	177.25
32 mm	170.32	172.32	173.32	176.32	177.32



Bone Surgery (Osteotomes, Gouges)





Bone Surgery (Mallets)

 WILLIGER 24 cm/9½"	 DOYEN 20.5 cm/8¼"	220g Ø 30 mm COLLIN 208.20 20 cm/7¾"	 LUCAE 19.5 cm/7¾"	300 Ø 30 mm COTTLE 215.19 19 cm/7½"	Ø 40 mm 520 gr OMBREDANNE 960.56 24 cm
Ø 26 mm 275g 200.01 Ø 28 mm 320g 200.02 Ø 30 mm 340g 200.03	Ø 25 mm 120g 204.01 Ø 30 mm 170g 204.02 Ø 35 mm 260g 204.03		Ø 19 mm 230g 214.01 Ø 25 mm 260g 214.02		
140g Ø 20 mm WILLIGER 216.01 16.5 cm/6½"	450g Ø 30 mm MEAD 220.17 19 cm/7½"	175g Ø 27 mm PARTSCH 224.18 19 cm/7½"	Ø 27 mm HAJEK 960.21 135 gr. 22 cm	Ø 22 960.22 155 gr 19 cm	Ø 30 mm Ø 42 mm 285 gr 960.43 24 cm
	 221.00 Spare facing pair				



Bone Surgery (Mallets)





Bone Surgery (Bone Curettes)



SCHEDÉ

Fig.	17 cm/7"
000	300.30
00	320.20
0	300.10
1	301.01
2	301.02
3	301.03
4	301.04



VOLKMANN

Fig.	17 cm/7"
0000	304.40
000	304.30
00	304.20
0	304.10
1	305.01
2	305.02
3	305.03
4	305.04
5	305.05
6	305.06



BRUNS

Fig.	17 cm/7"
0000	308.40
000	308.30
00	308.20
0	308.10
1	339.01
2	339.02
3	339.03
4	339.04
5	339.05
6	339.06



BRUNS

Fig.	17 cm/7"
000	960.65
00	960.66
0	960.67
1	960.68
2	960.69
3	960.70
4	960.71



SPRATT

Fig.	20 cm
0000	312.40
000	312.30
00	312.20
0	312.10
1	313.01
2	313.02
3	313.03
4	313.04
5	313.05



SPRATT

Fig.	20 cm
0000	960.72
000	960.73
00	960.74
0	960.75
1	960.76
2	960.77
3	960.78
4	960.79
5	960.80



DAUBENSPECK

Fig.	17 cm/7"
0000	306.40
000	306.30
00	306.20
0	306.10



MODELL USA

Fig.	16.5 cm/6½"
1	344.01
2	344.02
3	344.03
4	344.04
5	344.05
6	344.06



MODELL USA

Fig.	16.5 cm/6½"
1	345.01
2	345.02
3	345.03
4	345.04
5	345.05
6	345.06



MODELL USA

Fig.	16.5 cm/6½"
1	347.01
2	347.02
3	347.03
4	347.04
5	347.05
6	347.06



HALLE

Fig.	25 cm/9¾"
1	350.01
2	350.02
3	350.03



Bone Surgery (Bone Curettes)



15 cm/6"
Fig. WILLIGER
00/00 **359.00**
0/0 **359.10**
1/1 **359.12**



JACOBSEN
351.14
14 cm/5½"



VOLKMANN
12.5 cm/4¾" **352.13**
14.5 cm/5¾" **352.14**
17.0 cm/6¾" **352.17**



VOLKMANN
13 cm/5" **354.13**
16 cm/6¼" **354.16**
20 cm/8" **354.20**



14 cm/5½"
Fig. WILLIGER
00/0 **358.00**
0/1 **358.01**
1/2 **358.12**



MOLT
395.24
19 cm/7½"



BUSHE
25 cm/9¾"
3 mm **348.03**
4 mm **348.04**
5 mm **348.05**



356.21
21 cm/8¼"



SCOVILLE
25 cm/9¾"
336.25
337.25
339.25



SIMON
Fig. 22.5 cm/8¾"
1 **340.01**
2 **340.02**
3 **340.03**
4 **340.04**
5 **340.05**
6 **340.06**



Fig. 25 cm/9¾"
000 **342.30**
00 **342.20**
0 **342.10**
1 **342.01**



BRUNS
23 cm/9"
Fig. 000 **334.30**
00 **334.20**
0 **334.10**
1 **335.01**
2 **335.02**
3 **335.03**
4 **335.04**
5 **335.05**
6 **335.06**



Bone Surgery (Periosteal Elevators)

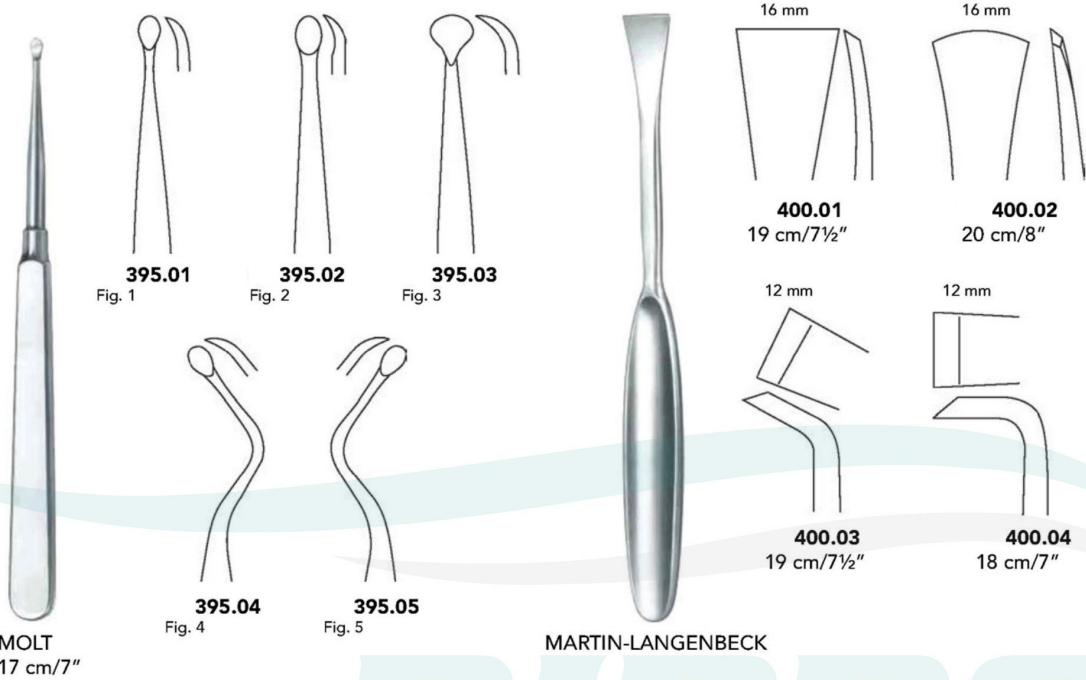

MOLT
17 cm/7"

MARTIN-LANGENBECK

DIPRO
Periosteal Elevators

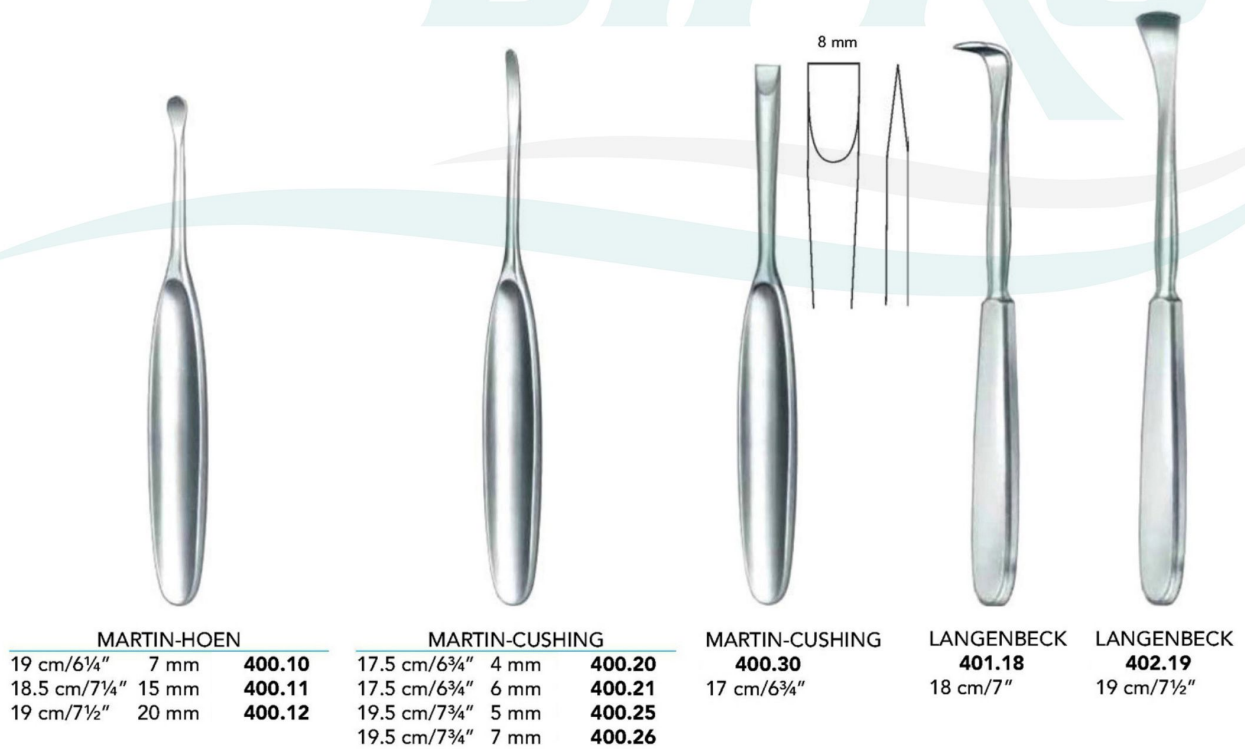



Bone Surgery (Periosteal Elevators)

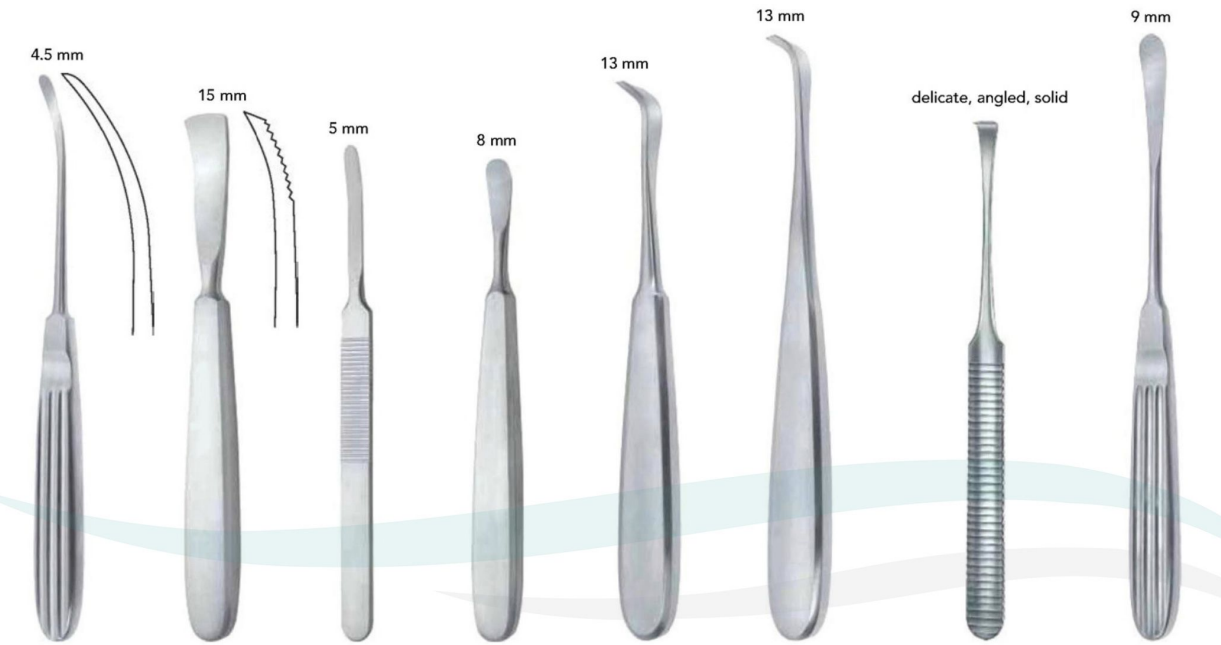

LANDOLT 404.18 17.5 cm/6¾"	JANSEN 405.17 16.5 cm/6½"	KOENIG 406.16 15.5 cm/6"	TRELAT 407.15 15 cm/6"	SCHNEIDER 408.18 17.5 cm/6¾"	SCHNEIDER- SAUERBRUCH 409.14 19 cm/7½"	16 cm/6¼" 5 mm 411.05 6 mm 411.06 7 mm 411.07	COTTLE 412.20 19 cm/7½"
--	---	--	--	--	--	---	---

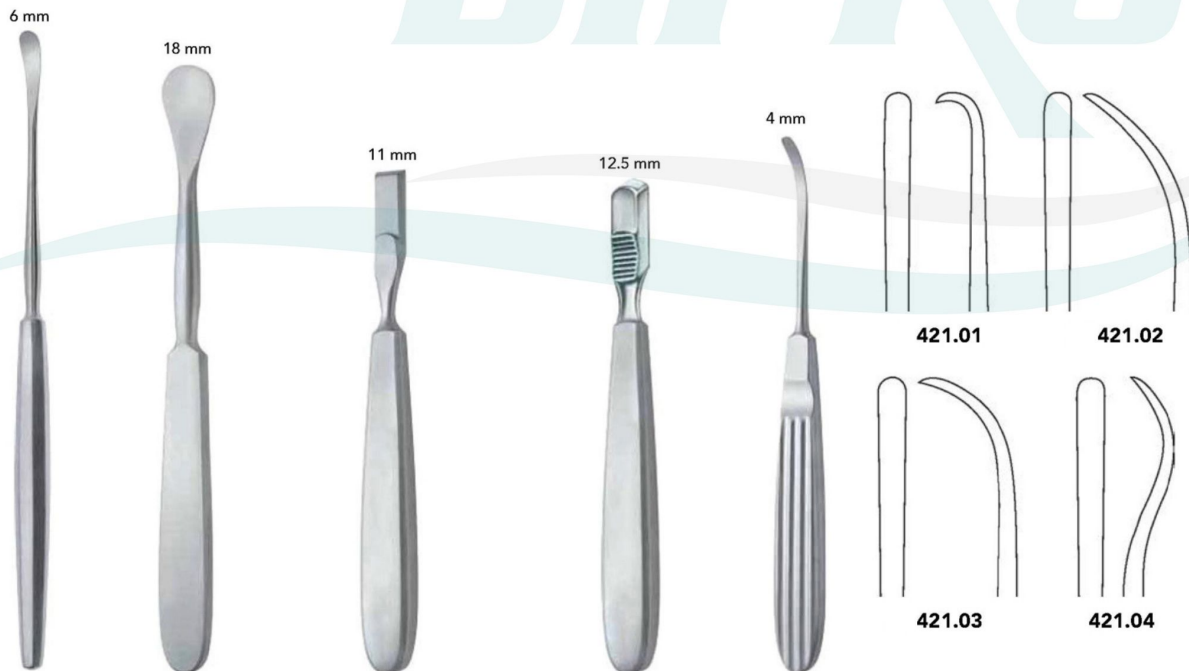

SEWALL 413.20 20 cm/8"	SEDILLOT 414.19 18.5 cm/7¼"	FARABEU-F-COLLIN 15.5 cm/6¼" Straight 416.11 Curved 417.11	FARABEU-F 15.5 cm/6¼" Straight 418.15 Curved 419.15	MÜHLING 17 cm/6¾"	421.01	421.02	421.03	421.04
--	---	--	---	-----------------------------	---------------	---------------	---------------	---------------



Bone Surgery (Periosteal Elevators)



KEY

18 cm/7¼"	3 mm	423.01
18 cm/7¼"	6 mm	423.02
19 cm/7½"	10 mm	423.03
19 cm/7½"	13 mm	423.04
20 cm/8"	16 mm	423.05
20 cm/8"	19 mm	423.06
21 cm/8¼"	25 mm	423.07



COBB

	23 cm/9"	28 cm/11"
6 mm	426.06	425.06
10 mm	426.10	425.10
13 mm	426.13	425.13
19 mm	426.19	425.19
25 mm	426.25	425.25



SEDILLOT
427.21
23 cm/9"



KAHRE-WILLIGER
16.5 cm/6½"



436.04

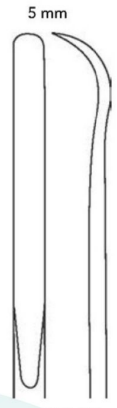

436.05

7 mm



WILLIGER
436.07
16 cm/6¼"

6 mm



WILLIGER
434.13
12.5 cm/5"

5 mm



WILLIGER
436.16
16 cm/6¼"



17 cm/7"

3 mm	438.03
6 mm	438.06



17 cm/7"

6 mm	439.06
8 mm	439.08



Bone Surgery (Periosteal Elevators)



DOYEN

Right Curved

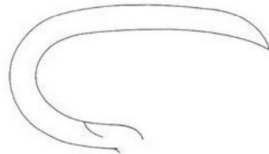

441.17
17 cm/6¾"

Left Curved



443.17
17 cm/6¾"

Right Curved

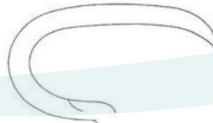

445.17
18 cm/7"

Left Curved



447.17
18 cm/7"



ALEXANDER
448.21
21 cm/8¼"

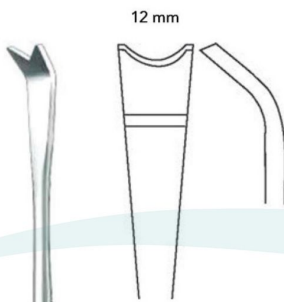

450.01
19 cm/7½"
Fig. 1



450.02
22 cm/8¾"
Fig. 2

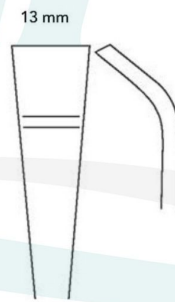

450.03
19 cm/7½"
Fig. 3

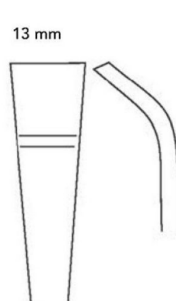

450.04
22 cm/8¾"
Fig. 4



450.05
23 cm/9"
Fig. 5

SEMB

LAMBOTTE
21.5 cm/8½"
5 mm **461.05**
10 mm **461.10**
15 mm **461.15**
20 mm **461.20**
25 mm **461.25**





Bone Surgery (Bone Files & Elevators)

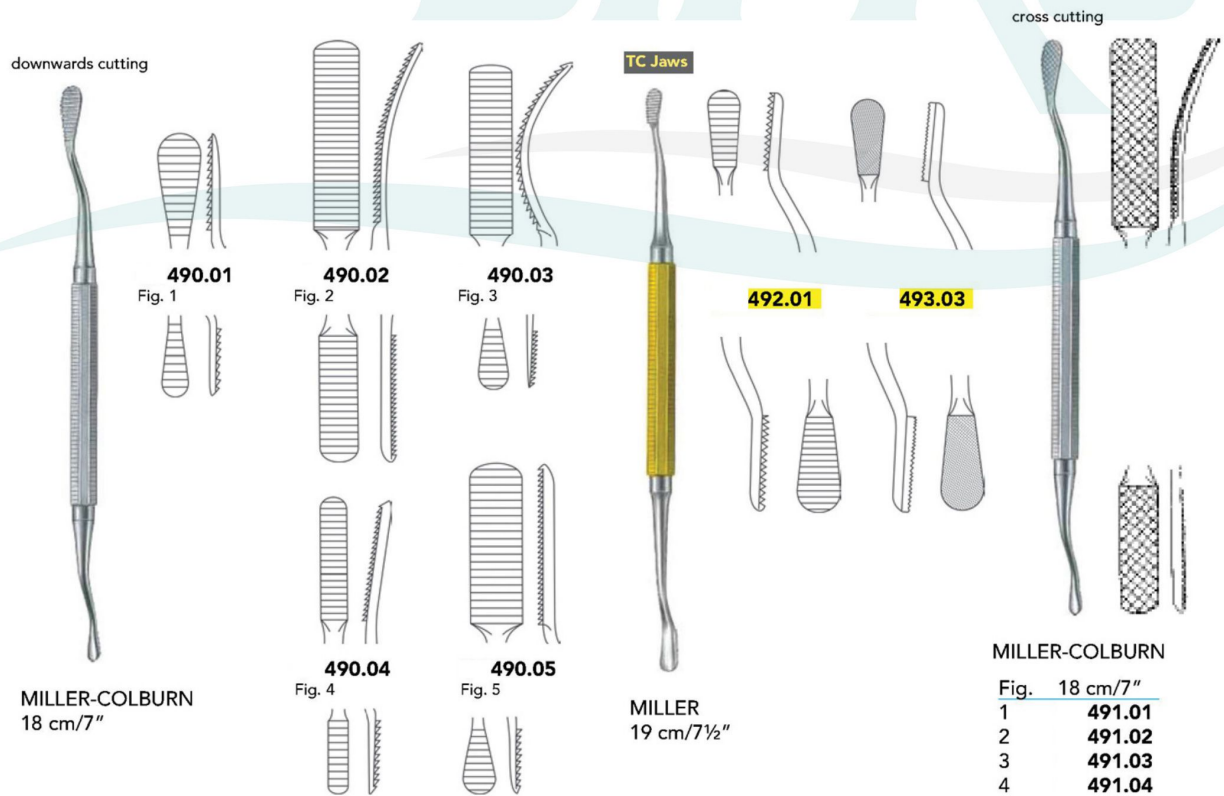
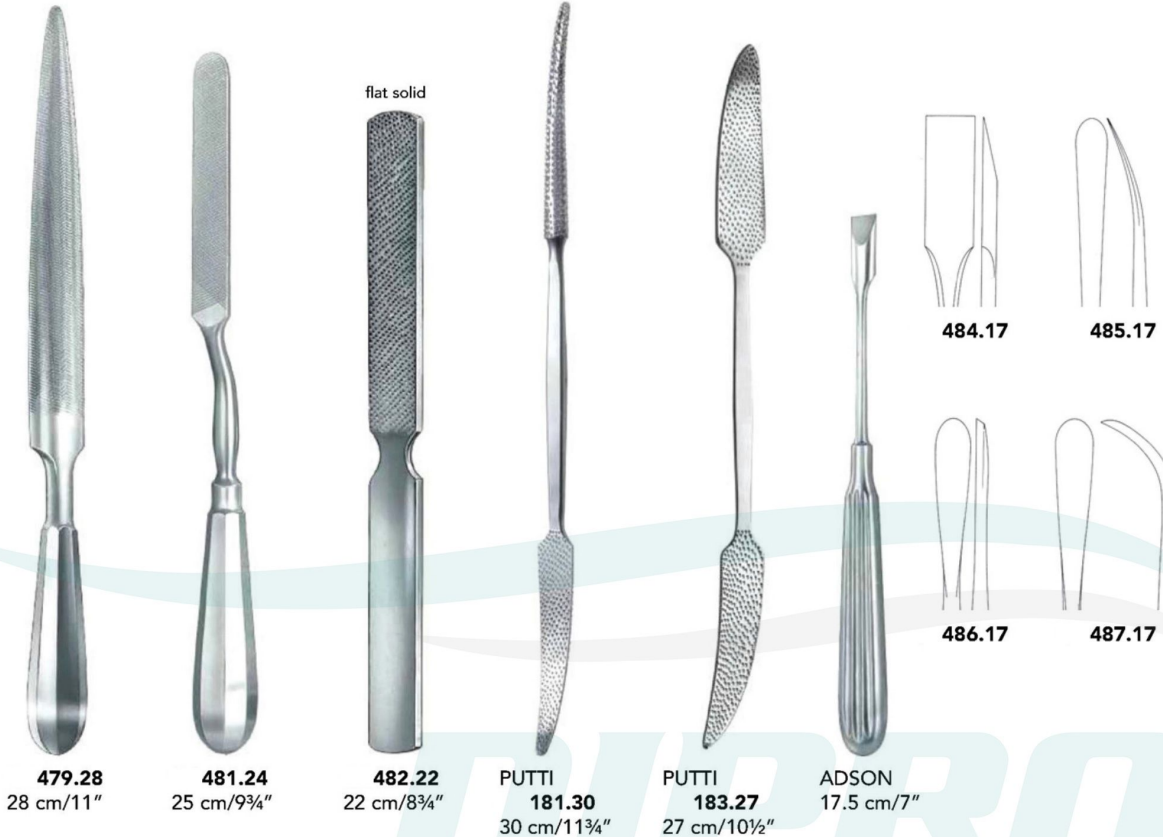



Bone Surgery (Elevators & Bone Levers)



LANGENBECK

19.5 cm/7¾"	7 mm	495.20
19.5 cm/7¾"	10 mm	497.20
23 cm/9"	11 mm	498.23

7 mm



WILLIGER
510.17
17 cm/7"

4 mm



WILLIGER
513.16
16 cm/6¼"

5 mm



SEBILEAU
516.18
17.5 cm/7"

6 mm



QUERVAIN
517.20
19.5 cm/7¾"



ALDERDYCE
525.21
21 cm/8¼"



MCDONALD
527.19
18.5 cm/7¼"

2.8 mm

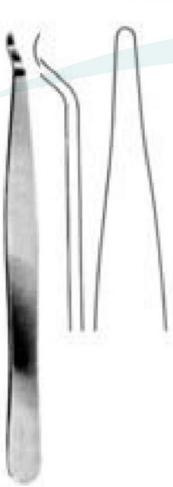

960.63
14 cm

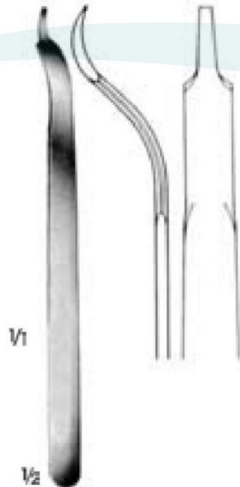

BUCK-GRAMCKO
960.62
15 cm

2 mm



537.06
15 cm/6"



HOHMANN, MINI
16 cm/6¾"
6 mm **539.06**
8 mm **539.08**

15 mm



539.15
16 cm/6¾"
539.16
12 cm 15 mm



BENNETT
24 cm/9½" 43 mm **559.24**
23.5 cm/9¼" 60 mm **561.24**



Bone Surgery (Bone Levers)

Knee Retractors

39 mm



BLOUNT
563.26
26.5 cm/10½"

47 mm



BLOUNT
565.26
26.5 cm/10½"

8 mm



HOHMANN
541.08
21.5 cm/8¾"

18 mm



HOHMANN
541.18
23.5 cm/9½"

43 mm



HOHMANN
541.43
23.5 cm/9½"

70 mm



HOHMANN
541.70
25 cm/9¾"

43 mm



HOHMANN
543.43
23.5 cm/9½"

22 mm



HOHMANN
545.22
25.5 cm/10¼"

35 mm



HOHMANN
545.35
29 cm/11½"

24 mm



HOHMANN
547.24
27.5 cm/10¾"

22 mm



LANGE-HOHMANN
549.22
25 cm/9¾"



Bone Surgery (Spinal Retractors, Meniscus Knives, Tendon Strippers)

C
OB960.32
Ø 2 mm

C
960.33
Ø 3 mm

C
960.34
Ø 4 mm

C 1/1
960.35
Ø 6 mm

960.37
Ø 4 mm

960.38
Ø 4.5 mm

960.39
Ø 5.5 mm

Esnek şaft/Flexible shaft
23 cm

TAYLOR
16 cm/6¼"

95 x 30 mm **571.16**

115 x 30 mm **573.16**

BLOUNT
567.17
17.5 cm/6¾"

BUNNELL
13.5 cm

630.17
Fig. 1

631.17
Fig. 2

633.17
Fig. 3

NEFF
22 cm/8¾"

SALENIUS
21.5 cm/8½"

FISCHER
660.31
31 cm/12¼"

662.29
28.5 cm/11¼"

BUNNELL
664.23
23 cm/9"

Tendon Passer



Bone Surgery (Tendon Holding Forceps, Tendon Tunnelling Forceps)

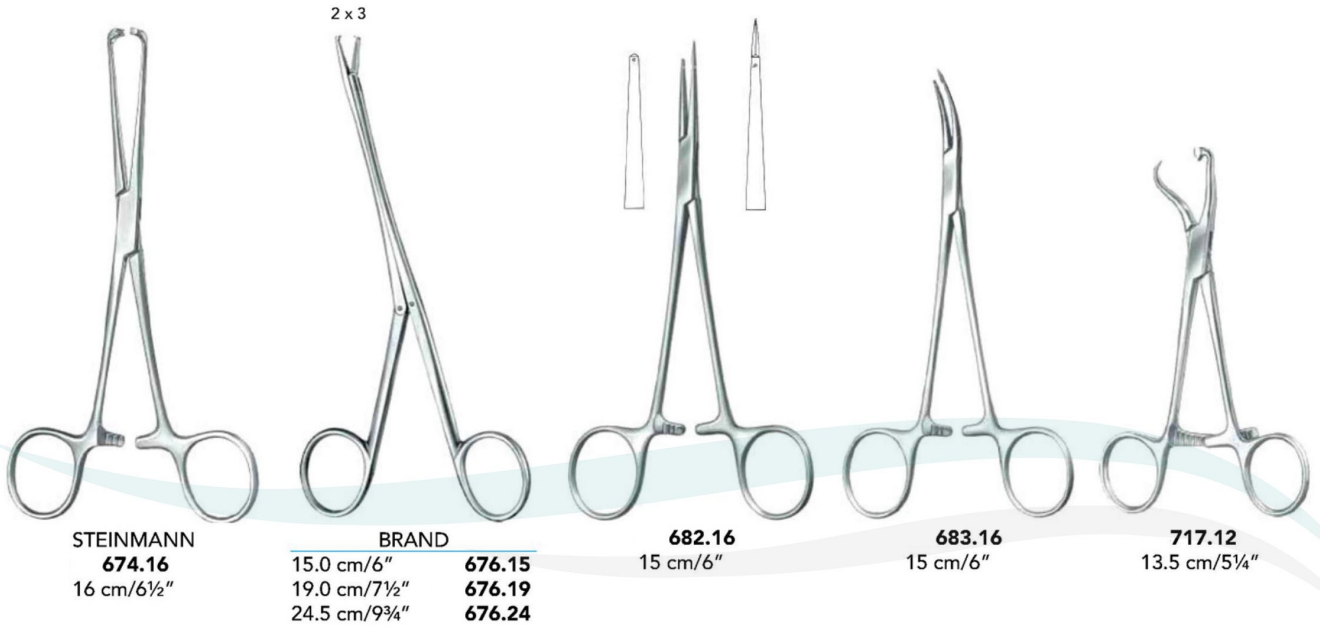

STEINMANN
674.16
16 cm/6½"

2 x 3
BRAND
15.0 cm/6"
19.0 cm/7½"
24.5 cm/9¾"

682.16
15 cm/6"

683.16
15 cm/6"

717.12
13.5 cm/5¼"

DIPRO

Bone holding forceps



704.14
14.5 cm/5¾"



680.13
11.5 cm/4½"



BIRCHER-GANSKE
21.0 cm/8¼" Straight **710.20**
20.5 cm/8" Curved up **611.20**



BIRCHER-GANSKE
713.20
20 cm/8"



Bone Surgery (Tendon Holding Forceps, Tendon Tunnelling Forceps)



2:3
21.0 cm/8¼"
Straight Curved
678.00 **678.01**



LEWIN
718.17
18 cm/7"



MARTIN
716.19
18.5 cm/7¼"

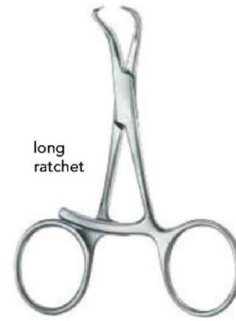

long
ratchet

721.09
14 cm/5½"



1/1

960.28
Pozisyon pensi
Reposition forceps
20.5 cm



Bone holding forceps

DINGMANN
OB715.19
18.5 cm/7¼"



long ratchet

721.14
14 cm/5½"



delicate

716.14
14 cm/5½"



CARROLL
679.11
11.5 cm/4½"



Bone Surgery (Bone Holding Forceps)



LANGENBECK
722.21
21 cm/8¼"



FERGUSSON
724.21
21 cm/8¼"



FROSCH
726.18
18 cm/7"



727.20
20 cm/8"



729.16
17.5 cm/7"

with thread fixation



729.24
17.5 cm/7"

with thread fixation



KERN
17.0 cm/6¾" **730.17**
24.5 cm/9¾" **730.21**



SEMB
731.19
19.5 cm/7¾"



732.23
23 cm
734.26
26 cm/10¼"



Bone Surgery (Bone Holding Forceps)



ULRICH

	Straight	Angled
23 cm/9"	746.23	747.23
25 cm/10"	746.25	747.25
28 cm/11"	746.28	747.28



1/2

VERBRUGGE
960.61
17.5 cm



VERBRUGGE

25 cm/10"	755.01
26 cm/10 1/4"	755.02
27.5 cm/10 3/4"	755.03



LANE
33 cm/13"

With Ratchet	Without Ratchet
750.33	752.33

detachable, Amputation Retractor

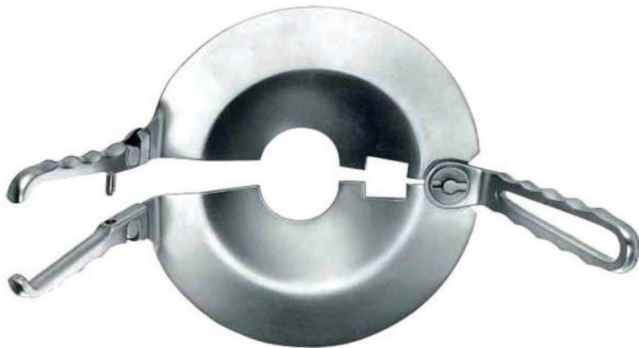

PERCEY
762.30



LOWMAN

16 cm	960.29
18 cm	960.30
20 cm	960.31



Bone Surgery (Bone Rongeurs)



STELLBRINK



FRIEDMANN
799.12
12.5 cm/4¾"



FRIEDMANN
801.14
13.5 cm/5¼"



FRIEDMANN
803.14
13.5 cm/5¼"



CLEVELAND
805.14
13.5 cm/5¼"

DIPRO



CLEVELAND
807.17
16.5 cm/6½"



MEAD
815.16
16.5 cm/6½"



MEAD
816.16
16.5 cm/6½"



HARTMANN
819.18
17.5 cm/7"



LUER
18.0 cm/7"
Straight **846.17**
Curved **847.17**



Bone Surgery (Bone Rongeurs)



JANSEN

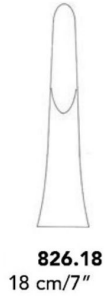

BLUMENTHAL
16.0 cm/7"

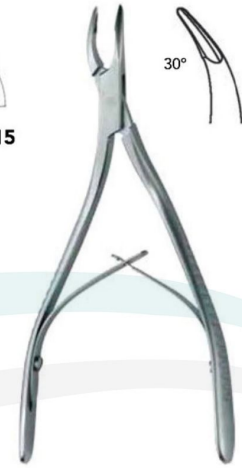
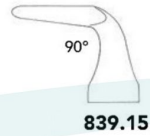
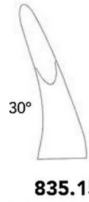

835.30
15.5 cm/6"



836.00
15.5 cm/6"



836.30
15.5 cm/6"



836.90
14.5 cm/5¾"



ZAUFAL-JANSEN
881.30
18 cm/7"



Bone Surgery (Bone Rongeurs)



BEYER
879.18
18 cm/7"



MAYFIELD
883.17
18 cm/7"



MARQUARD
885.20
20.5 cm/8"



RUSKIN
887.18
19 cm/7½"



LEMPERT
19 cm/7½"
Straight **832.19** Curved **833.19**



LUER
14.5 cm/5¾"



853.15

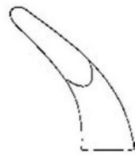

864.15



BOEHLER ½
15 cm/6"
Straight **876.15** Curved **877.15**



OLIVECRONA
960.54
20.5 cm



Bone Surgery (Bone Rongeurs)



SEMB
895.22
23.5 cm/9¼"



FRYKHOLM
909.24
24.5 cm/9½"



4 mm

8 mm

811.22

810.22

LEKSELL-STILLE
24.5 cm/9½"



ECHLIN
23 cm/9"

2 mm

899.02

3 mm

899.03

4 mm

899.04



STILLE-RUSKIN
901.23
23.5 cm/9¼"



RUSKIN
893.23
24 cm/9½"



Bone Surgery (Bone Rongeurs)



STILLE
897.23
22.5 cm/8¾"



SAUERBRUCH
31 cm/12¼"

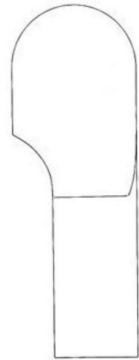

918.30

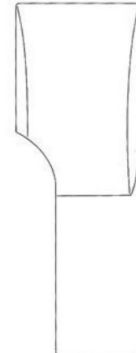

916.30



LEKSELL-STILLE
1000.01
24 cm



STILLE-LUER

	Straight	Curved
23 cm/9"	912.23	913.23
27 cm/10¾"	912.27	913.27



Bone Surgery (Bone Cutting Forceps)



COTTLE-KAZANJIAN
930.19
19 cm/7½"

Straight



LISTON
14 cm/5½" **934.14**
17 cm/6¾" **934.17**
20 cm/8" **934.19**
22 cm/8¾" **934.22**

Curved



LISTON
14 cm/5½" **935.14**
17 cm/6¾" **935.17**
20 cm/8" **935.19**
22 cm/8¾" **935.22**



CLEVELAND
939.17
17 cm/7"



CLEVELAND
941.15
14.5 cm/5¾"



BOEHLER
944.15
14.5 cm/5¾"



BOEHLER
946.15
14.5 cm/5¾"



CLEVELAND
947.16
17 cm/7"



950.18



951.18



RUSKIN-LISTON
17 cm/7"



Bone Surgery (Bone Cutting Forceps)



SEMB
959.24
24.5 cm/19³/₄"



STILLE-LISTON
952.27
17 cm/7"



STILLE-LISTON
23.5 cm/10³/₄" **955.23**
28 cm/11" **955.27**



STILLE-LISTON
954.27
28 cm/11"



LISTON-KEY
957.27
26 cm/10¹/₄"



Bone Surgery (HAND SAWS)

BIER

960.23 Komple/Complete

42 cm

Length blade

Bleyd uzunluđu

27 cm

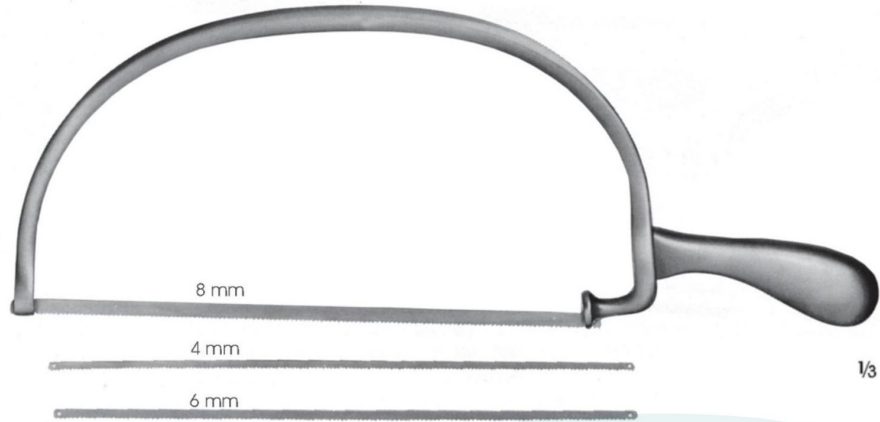

CHARRIERE

960.24 Komple/Complete

35 cm

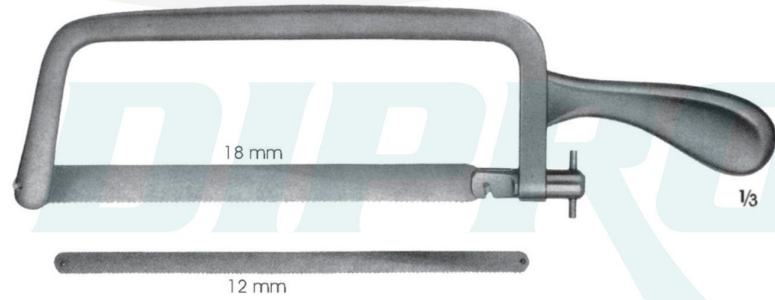

CHARRIERE

960.25 27 cm

960.26 34 cm



SATTERLEE

960.27

29 cm

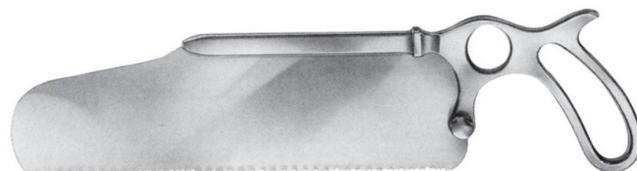



Bone Surgery (Wire Bender Pliers & Extractors)



960.57
Tırtıllı ağız
With serrated jaws

Tel bükücü, düz burunlu
wire twister, flat nosed
17 cm



960.41
Boylamasına ve
çapraz kanallı
With longitudinal
and transversal
grooves



960.42
Tel tutma pensi, düz burunlu
Wire holding forceps, flat nosed
19 cm



MARBURG MODELL
960.64
Tel tutma pensi,
Düz burunlu, tırtıllı ağız
Wire holding forceps,
Flat nosed, with serrated jaws
14 cm



960.53
Çıkartıcı/Extractor
25 cm



961.53
Çıkartıcı/Extractor
27 cm

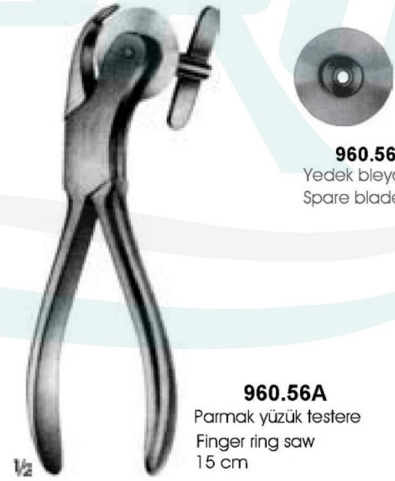

960.56A
Parmak yüzük testere
Finger ring saw
15 cm

960.56B
Yedek bleyd
Spare blade

960.55
STAPLER SÖKÜCÜ
STAPLER REMOVER
9 cm





Bone Surgery (Wire Cutting Pliers & Nippers)



Flat nose pliers

505.17
17 cm/6¾"



507.18
18 cm/7"



Flat nose plier

Hackstock
518.16
16 cm/6¼"



Wire nipper

MARTIN-Diamant
522.16
16 cm/6¼"

DIPRO



Extracting forceps

511.01
18 cm/7"



TC Jaws



Side-cutting plier

523.22
22 cm/8¾"

TC Jaws

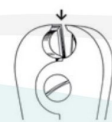

Combination cutting plier

526.18
22 cm/8¾"

TC Jaws



Wire twisting forceps

500.20
20 cm/8"



Bone Surgery (Wire Cutting Pliers & Nippers)



Yumuşak tel için Ø 3.0 mm
For soft wire Ø 3.0 mm
Sert tel için Ø 2.2 mm
For hard wire Ø 2.2 mm

1000.01
Yanal kesme
Lateral cutting
23.5 cm



Yumuşak tel için Ø 3.0 mm
For soft wire Ø 3.0 mm
Sert tel için Ø 2.0 mm
For hard wire Ø 2.0 mm

1000.02
22 cm



Yumuşak tel için Ø 2.0 mm
For soft wire Ø 2.0 mm
Sert tel için Ø 1.5 mm
For hard wire Ø 1.5 mm

REILL
1000.04
17.5 cm



KIRSCHNER
1000.06
32 cm



1000.05
Ø 6 mm kadar tel, vida, çivi vs. kesmek için
For cutting off wires, screws, pins, etc. up to Ø 6 mm
47 cm



Bone Surgery (Bending Pliers, Plate Cutter)



Bending press

229.30

Plate cutter



528.55
55 cm/22"

Plate bending plier



229.20

Bending pliers for small plates



229.22
22 cm/8¾"

Plate bending plier



124.16
16 cm/6¼"



Bone Surgery (Gauges, Measuring Sleeves, Drill Bit Guides)

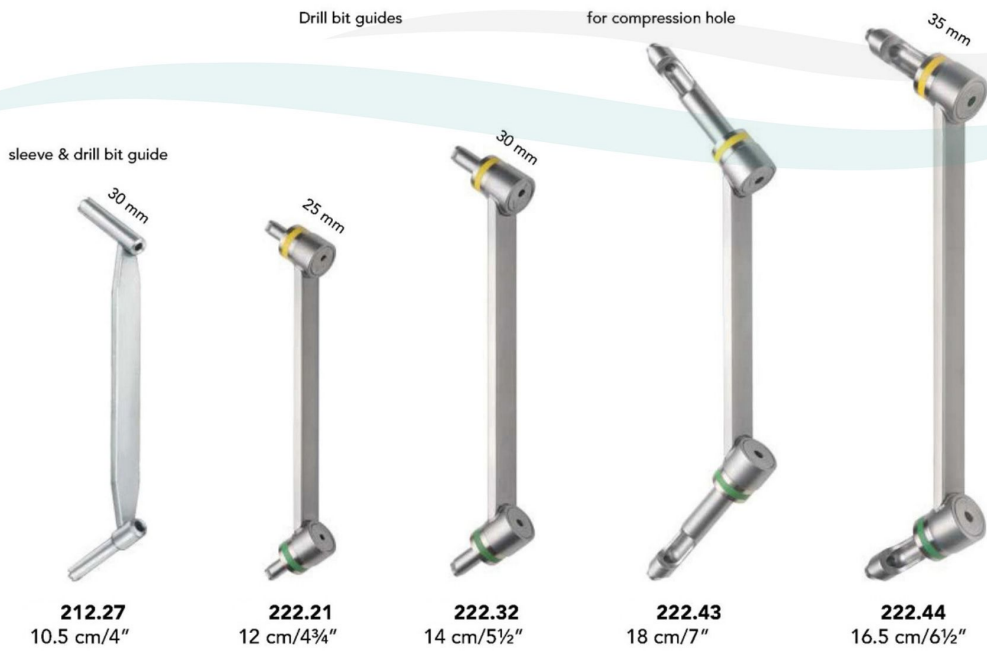
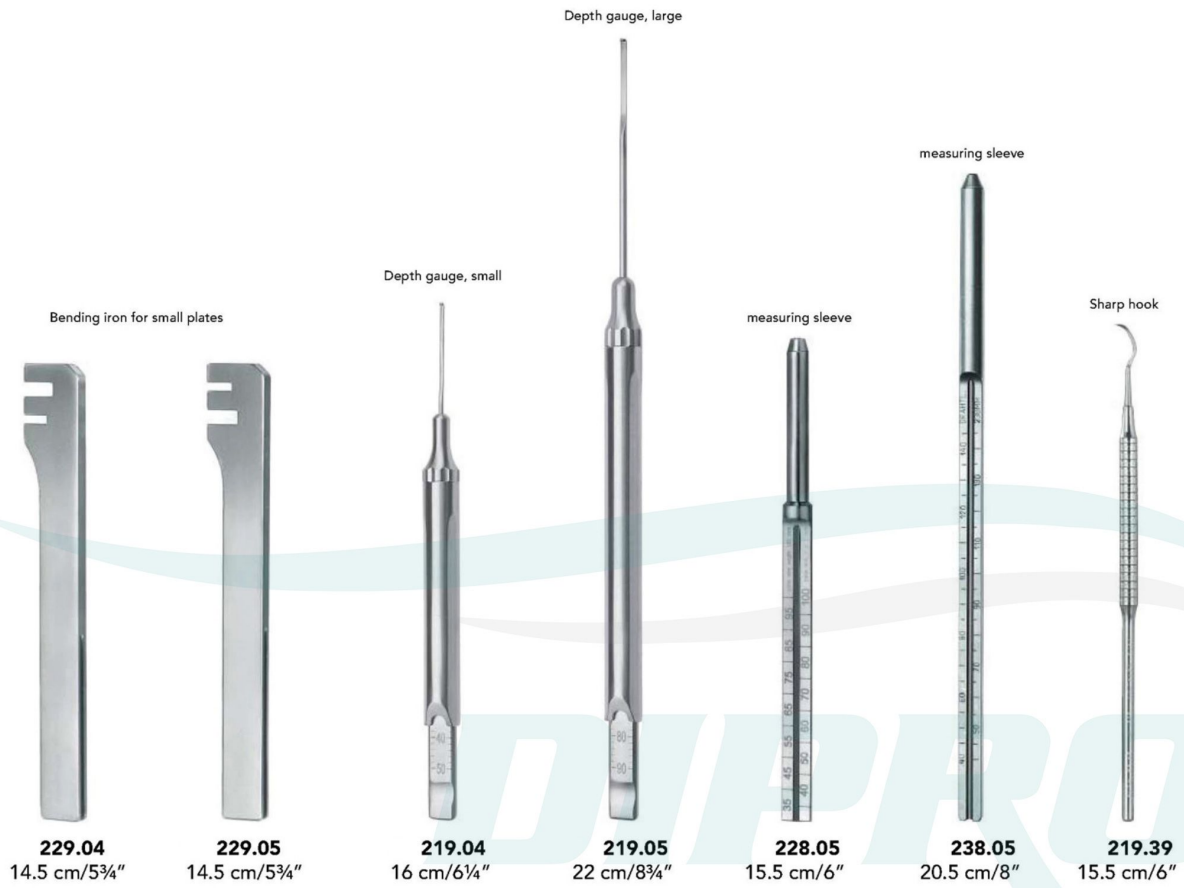



Bone Surgery (Wire Traction Bows)

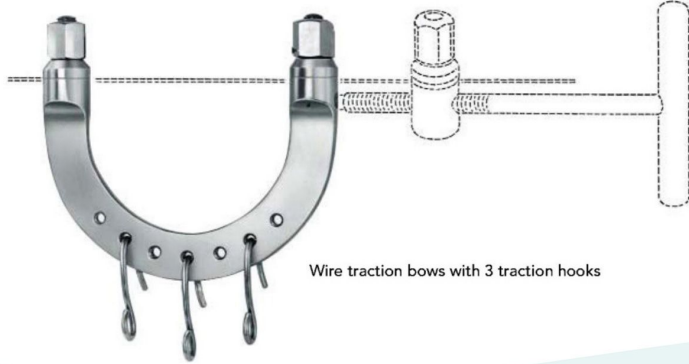

Wire traction bows with 3 traction hooks

KIRSCHNER

95 x 70 mm	581.01
105 x 105 mm	581.02
120 x 120 mm	581.03
155 x 155 mm	581.04

Wire strainer



586.18
18.5 cm/7¼"

Traction hook for extension bows



603.06
18.5 cm/7¼"



with 3 traction hooks

KIRSCHNER

18.5 cm/7¼"	585.01
26.5 cm/10¼"	585.02

Wrench



587.20
20 cm/8"



180 x 100 mm	589.18
270 x 160 mm	589.27



Bone Surgery (Hand Drills, Wire Traction Bows)

Ø 4 mm



Steinmann Pins, with trocar tip
 14 cm/5½" **562.14**
 16 cm/6¼" **562.16**
 18 cm/7" **562.18**
 20 cm/8" **562.20**

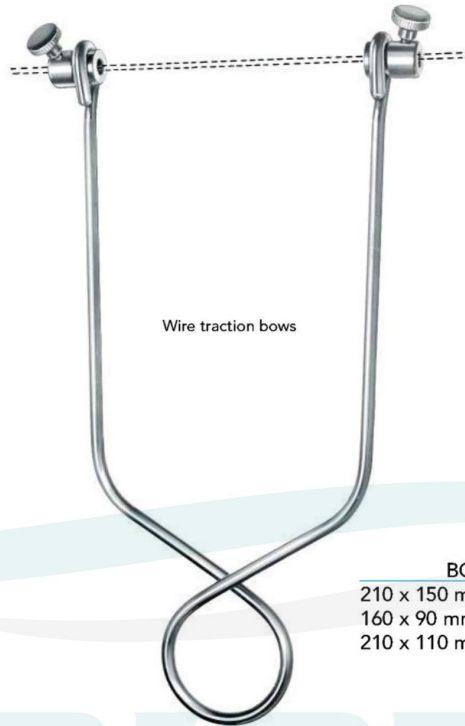

Wire traction bows

BOEHLER
 210 x 150 mm **565.15**
 160 x 90 mm **565.16**
 210 x 110 mm **565.21**

with three jaw chuck, longitudinal bore

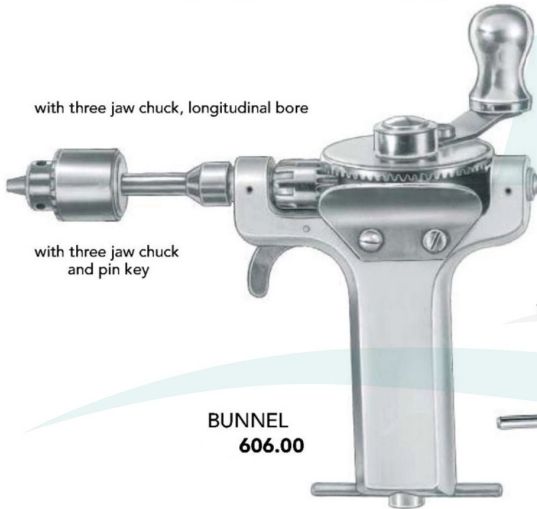

BUNNEL
606.00

with three jaw chuck and pin key

Wrench



620.99

with three jaw chuck



RALK
611.01



620.05

Handle with three jaw chuck, with key

Ayarlı sap
Adjustable handle



1000.03
El matkabı/Hand drill only
28 cm



Anahatar/Key



Bone Surgery (Screw Drivers)

2.5 mm

368.21
 21 cm/8¼"

3.5 mm

369.21
 21 cm/8¼"

4.5 mm

369.25
 25 cm/10"

6 mm

372.17
 17 cm/6¾"

6 mm

 LANE
372.25
 25 cm/10"

6 mm

378.25
 25 cm/10"

PHILIPS

380.25
 25 cm/10"



Bone Surgery (Hand Surgery)

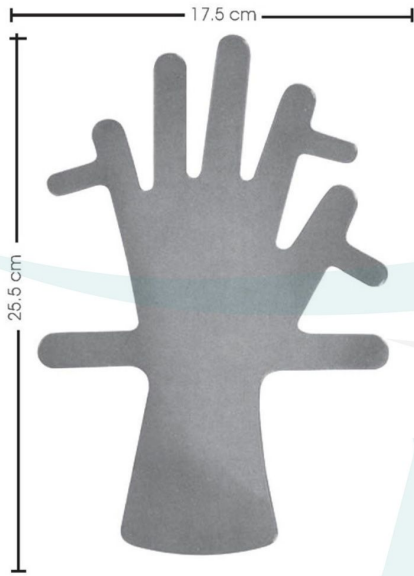

960.58
Çocuklar için el sabitleyici, yumuşak
Children's hand control, soft



960.59
Yetişkinler için el sabitleyici, yumuşak
Used stabilizer for adults, soft



960.60